

SAVINGS & STYLE



**VEZZOSI**EMPORIO



# Istruzioni per la lettura del listino

instructions for the price list

instructions pour lire la liste des prix

instruciones por la lista de precios

Ad ogni articolo del presente catalogo è stato abbinato un codice numerico denominato "codice prezzo".

Il "codice prezzo" trova sul listino allegato al catalogo il valore corrispondente in euro dell'articolo considerato.

Every article in this catalogue has got a numeric code called "price code". In the price list the price code corresponds to the price in euro of the considered article.

À chaque article de ce catalogue on a attribué un "code prix".

Dans la liste des prix le code prix correspond au prix en euro de l'article considéré .

Á cada artículo de este catalogo hemos dado un "codigo precio".

En la lista the precios el codigo precio corresponde al precio en euro del artículo considerado.

**VEZZOSI**EMPORIO



# 4-75 prodotti

products . produits . productos

Una varietà di prodotti tutti rigorosamente made in Italy:  
una scelta forte e consapevole che tutela la qualità e  
garantisce lo standard di produzione.

A big variety of articles made in Italy to defend and  
guarantee an high standard of production.

Une variété de produits absolument made in Italy: un  
choix fort qui protège la qualité

Una grande variedad de productos made in Italy para  
proteger y garantizar un alto nivel de producción.

# 76-77 tappezzeria

upholstery . tapisserie . tapiceria

Un'attenta selezione di colori per garantire  
le migliori soluzioni.

A meticulous selection of colours guarantees  
the best solutions.

Des couleurs sélectionnés avec le plus grand soin,  
pour garantir les meilleurs résultats.

Colores seleccionados cuidadosamente para  
garantizar las mejores soluciones.

# 78-80 schemi idraulici

water-system diagrams . schémas hydrauliques . esquemas hidráulicos

# posti lavoro 4/19

styling units . coiffeuses . tocadores



IKON  
Art.  
8245  
Pag. 4

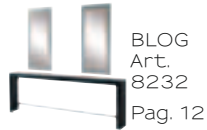

BLOG  
Art.  
8232  
Pag. 12



KIMERA  
Art.  
8228  
Pag. 5



CLASH  
Art.  
8230  
Pag. 13



BAUHAUS  
GLASS  
Art.  
8260  
Pag. 6



MOVIE  
Art.  
8241  
Pag. 14



BAUHAUS  
SHORT  
Art.  
8261  
Pag. 7



RIHANNA  
Art.  
8240  
Pag. 15



J-LO SHINE  
Art.  
8226  
Pag. 8



DOT  
Art.  
8216  
Pag. 16



J-LO GLASS  
Art.  
8227  
Pag. 9



4-U  
Art.  
8215  
Pag. 17



ANDY  
Art.  
8262  
Pag. 10



STRIPE  
Art.  
8217  
Pag. 18



BANNER  
Art.  
8231  
Pag. 11



KORA  
Art.  
8225  
Pag. 19

# poltrone lavoro 20/31

rotating chairs . fauteuils de travail . sillones de trabajo



UMA  
Art.  
8155  
Pag. 20



ANOUK  
Art.  
8124  
Pag. 28



COCONUT  
Art.  
8130  
Pag. 21



TRAFALGAR  
Art.  
8175  
Pag. 29



MEG  
Art.  
8245  
Pag. 22



CUBE  
Art.  
8100  
Pag. 30



APPLE  
Art.  
8136  
Pag. 23



GLAM  
Art.  
8105  
Pag. 31



MUSA  
Art.  
8161  
Pag. 24

# lavaggi 32/40

wash systems . bacs de lavage  
lavacabezas



WINONA  
Art.  
8171  
Pag. 25



SID  
Art.  
8050  
Pag. 32



KELLY  
Art.  
8167  
Pag. 26



BLUR  
Art.  
8030  
Pag. 33



DOLCENERA  
Art.  
8153  
Pag. 27



ANOUK  
WASH  
Art.  
8009  
Pag. 34

# lavaggi 32/40

wash systems . bacs de lavage  
lavacabezas



MEG WASH  
Art.  
8022  
Pag. 35



COCONUT  
WASH  
Art.  
8021  
Pag. 36



SPONGY  
Art.  
8015  
Pag. 37



JAM  
Art.  
8013  
Pag. 38



CUBE  
WASH  
Art.  
8000  
Pag. 39



GLAM  
WASH  
Art.  
8005  
Pag. 40

# service 41



STYLE  
Art.  
8250  
Pag. 41

## poltrone attesa 42/45

waiting chairs . fauteuils  
d'attente . sillones de espera



COCONUT  
WAITING  
Art.  
8302  
Pag. 42



SWEET  
Art.  
8300  
Pag. 43



FEEL  
Art.  
8310  
Pag. 44

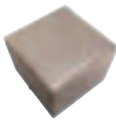

SINGLE  
Art.  
8305  
Pag. 45

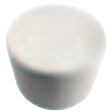

ROUND  
Art.  
8315  
Pag. 45

## tavoli cassa 46/53

cash register tables . tables  
caisse . receptiones

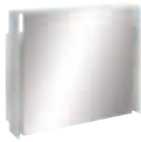

BRITNEY  
Art.  
8412  
Pag. 50



FLAT  
LIGHT  
Art.  
8401  
Pag. 51



SPICE  
Art.  
8410  
Pag. 52



SPRING  
Art.  
8420  
Pag. 53

## mobili servizio 58/61

salon furnishings . meubles de  
rangement . muebles servicio



Art.  
8730  
Pag. 58



Art.  
8731  
Pag. 59



Art.  
8725  
Pag. 60

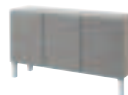

Art.  
8720  
Pag. 60



Art.  
8705  
Pag. 61



Art.  
8700  
Pag. 61

## estetica 62/75

beauty items . esthétique . estética



BIJOU  
Art.  
10070/N  
Pag. 62



KIMI  
Art.  
10060/B  
Pag. 69



LOU  
Art.  
10080/N  
Pag. 63



NIKITA  
Art.  
10045/B  
Pag. 70



JOEY  
Art.  
10075/N  
Pag. 64



LOLITA  
Art.  
10040/B  
Pag. 71



ALICE  
Art.  
10085/N  
Pag. 65



KALLISTO  
Art.  
10020/B  
Pag. 72



NELLY  
Art.  
10095/N  
Pag. 65



CHICO  
Art.  
10030/B  
Pag. 73



IGGY  
Art.  
10090/N  
Pag. 66



KARMA  
Art.  
10000/B  
Pag. 74



CINDY  
Art.  
10100/N  
Pag. 67



DIONISO  
Art.  
10010/B  
Pag. 75



SAKURA  
Art.  
10050/B  
Pag. 68

## tavoli cassa mobili expo

cash register tables . tables  
caisse . receptiones 46/53

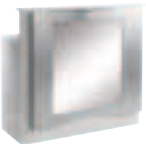

BAUHAUS  
Art.  
8413  
Pag. 46



J-LO  
Art.  
8415  
Pag. 47



AMY  
Art.  
8411  
Pag. 48



LUMINOL  
Art.  
8414  
Pag. 49

expo furnishings . meubles expo  
muebles expo 54/57



DADA EXPO  
Art.  
8604  
Pag. 54



KIMERA  
EXPO  
Art.  
8602  
Pag. 55



REALITY  
EXPO  
Art.  
8603  
Pag. 56



EXPO  
Art.  
8605  
Pag. 57

VEZZOSIEMPORIO



# Ikon

## Art. 8245

codice prezzo . price code .  
code prix . código de precio 001

Tavolo 4 posti lavoro,  
struttura in vetro  
temperato, piano lavoro  
in nobilitato nei 6 colori  
indicati.

Styling table 4 places,  
frame in temperate glass,  
top in pre-laminated in  
the 6 indicated colours.

Module central 4 places  
avec structure en verre  
temperé, plan de travail  
en laminé dans les 6  
couleurs indiquées.

Modulo central 4  
puestos, piernas en  
crystal templado,  
encimera en prelamado  
en los 6 colores indicados.

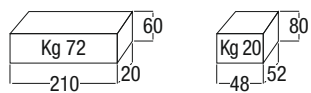
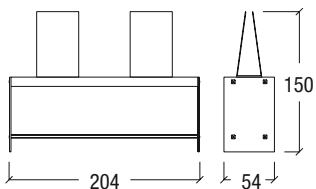

Nobilitato per piano lavoro. Pre-laminated for top.  
Laminé pour plan de travail. Prelaminado para encimera.

## Art. 8228

002 codice prezzo . price code .  
code prix . código de precio

Cornici decorative in legno  
colore bianco o nero, piano  
lavoro in vetro colorato bianco  
o nero, poggiatesta acciaio  
cromato lucido.

Decorative cornices in wood  
white or black, top in painted  
glass white or black, foot-rest  
in steel.

Cornices decoratives en bois  
blanc ou noir, plan de travail  
en verre blanc ou noir, repose  
pieds en acier inox.

Marcos en madera blanca o  
negra, encimera en crystal  
blanco o negro, apoja pies en  
acero cromado pulido.

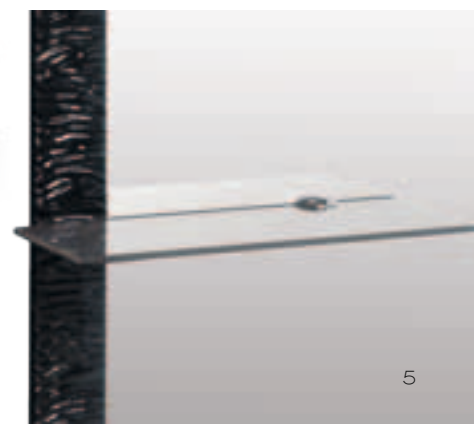
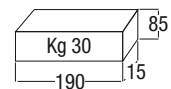
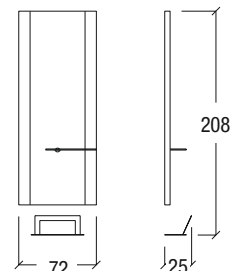

# Bauhaus Glass

Art. 8260

Pannello eterogeneo dibond automodellabile nei 3 colori indicati, inserto di sostegno in metallo, piano lavoro in vetro nero, poggia piede in acciaio cromato lucido.

Panel in dibond in the 3 indicated colours, top in glass black, foot-rest in steel.

Panneau en dibond dans le 3 couleur indiqués, tablette en verre noir, repose-pied en acier.

Panel en dibond en los 3 colores indicados, encimera en crystal negro, apoja-pies en acero.

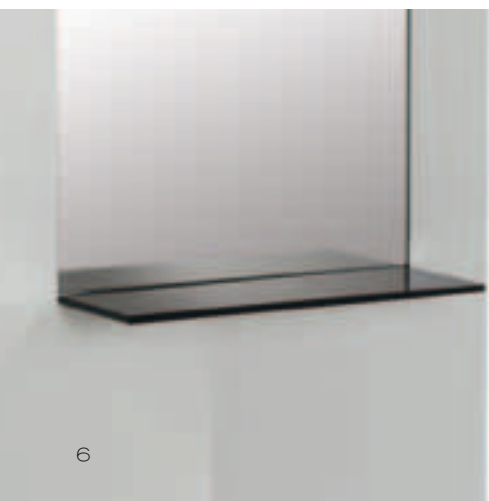
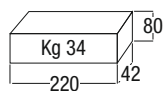
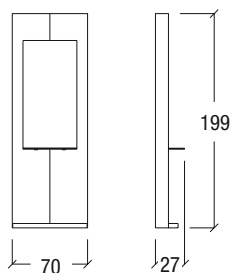

Dibond per pannello.  
Dibond for panel.  
Dibond pour panneau.  
Dibond para panel.



bianco

003



nero

004

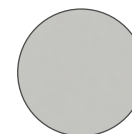

silver

005

codice prezzo . price code .  
code prix . código de precio



Art. 8261



Pannello eterogeneo dibond  
automodellabile e piano  
lavoro in legno laccato  
nei 3 colori indicati,  
senza poggia piede.

Panel in dibond and top in  
laquered wood in the  
3 indicated colours,  
no foot-rest.

Panneau en dibond et  
tablette en bois dans les 3  
couleurs indiquées,  
no repose-pied.

Panel en dibond y encimera en  
madera barnizada en  
los 3 colores indicados.  
Apoya pies no incluido.

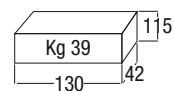
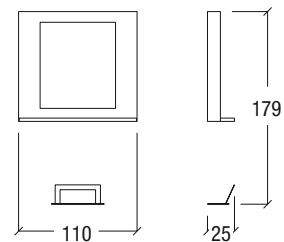

Dibond per pannello.  
Dibond for panel.  
Dibond pour panneau.  
Dibond para panel.

codice prezzo .  
price code .  
code prix .  
código de precio

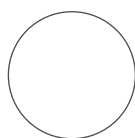

bianco **006**



nero **007**

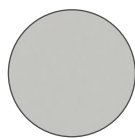

silver **008**



# J-LO Shine

## Art. 8226

codice prezzo . price code .  
code prix . código de precio **009**

Decorazioni laterali in skai con  
bottoni in cristallo brillante, piano  
lavoro e poggia piede in acciaio inox.

Lateral decorations in skai  
capitonné with buttons in shine  
crystal, top and foot-rest in steel.

Bandes laterales en skai capitonné  
par des boutons en cristal brillant,  
tablette et repose-pieds inox.

Decoraciones laterales en skai  
con botones de cristal brillante,  
encimera y apoja-pies en acero inox.

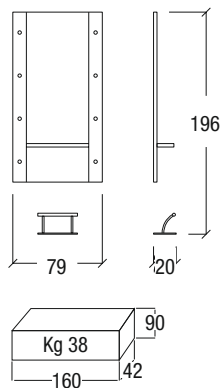

postì lavoro  
styling units . coiffeuses . tocadores

# J-LO Glass

Art. 8227

010 codice prezzo . price code .  
code prix . código de precio

Laterali in skai piano  
lavoro e poggiatesta  
in acciaio inox.

Lateral filets in skai, top  
and foot-rest in steel.

Bandes laterales en  
skai, tablette et repose-  
pieds inox.

Decoraciones laterales  
en skai, encimera y  
apoya-pies en acero inox.

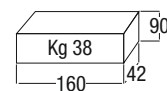
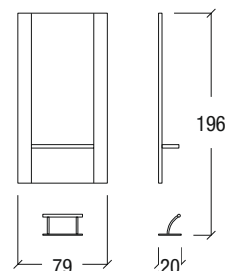

# Andy

## Art. 8262

codice prezzo . price code .  
code prix . código de precio 011

Superficie a specchio, scaffale  
in pannello eterogeneo dibond  
automodellante in colore bianco.  
Poggia piede in acciaio cromato  
lucido.

Mirror on all the surface, stand in  
dibond, white colour. Foot-rest in  
chromed metal.

Miroir sur toute la surface, étagère  
en dibond couleur blanc. Repose-  
pied en metal chromé.

Estante lateral en dibond blanco.  
Apoya pies en acero cromado pulido.

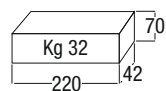
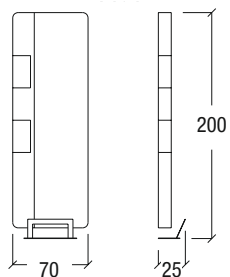

Art. 8231

012 codice prezzo . price code .  
code prix . código de precio

Modulo due posti lavoro, struttura  
in nobilitato nei 4 colori indicati,  
specchiera con cornice legno  
collezione metal millerighe.

Module for two styling units in pre-  
laminated in the 4 colours indicated,  
looking glass with cornice in wood  
collection Metal Millerighe.

Module pour deux places, structure  
en laminé dans les 4 couleurs  
indiquées, glace avec cadre en bois  
collection Metal Millerighe.

Modulo dos puestos de trabajo,  
estructura en prelaminao en los 4  
colores indicados, marco de Madera  
finicion Metal Millerighe.

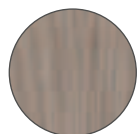
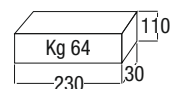
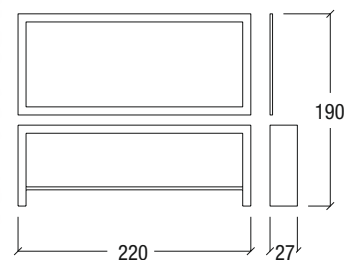

rovere



wengé

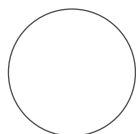

bianco lucido

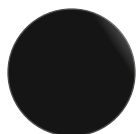

nero lucido

Nobilitato per piano lavoro. Pre-laminated for top.  
Laminé pour plan de travail. Prelaminado para encimera.



# Blog

## Art. 8232

codice prezzo . price code .  
code prix . código de precio **013**

Modulo per due posti lavoro,  
struttura in nobilitato nei 4  
colori indicati, specchiera in  
acciaio inox.

Module for two styling units in  
pre-laminated in the 4 colours  
indicated, looking glass with  
cornice in steel.

Module pour deux coiffeuses,  
structure en laminé dans les 4  
couleurs indiquées, glace avec  
cadre en inox.

Modulo dos puestos de trabajo,  
estructura en prelaminado en  
los 4 colores indicados, marcos  
en acero inox.

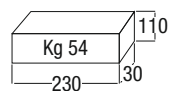
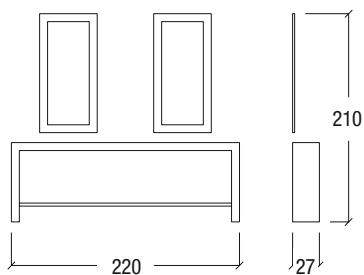

rovere

wengé

bianco lucido

nero lucido

Nobilitato per struttura. Pre-laminated for frame.  
Laminé pour structure. Prelaminado para estructura.

posti lavoro  
styling units . coiffeuses . tocadores

# Clash

Art. 8230

**O14** codice prezzo . price code .  
code prix . código de precio

Modulo per due posti  
lavoro, struttura in  
nobilitato nei  
4 colori indicati.

Module for two styling  
units, frame in pre-  
laminated in the 4 colours  
indicated.

Module pour deux places  
de travail. Structure en  
laminé dans les 4 couleurs  
indiquées.

Modulo dos puestos de  
trabajo, estructura en  
prelaminado en los  
4 colores indicados.

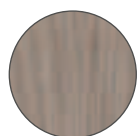
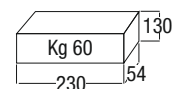
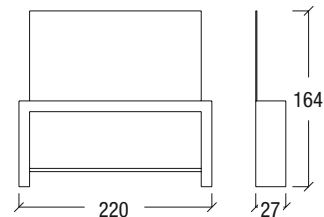

rovere



wengé

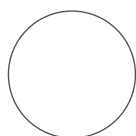

bianco lucido



nero lucido

Nobilitato per struttura. Pre-laminated for frame.  
Laminé pour structure. Prelaminado para estructura.



# Movie

## Art. 8241

codice prezzo . price code .  
code prix . código de precio **015**

Struttura in nobilitato nei colori indicati, piano lavoro in vetro colorato bianco o nero, poggiapiede acciaio.

Frame in pre-laminated in the 3 indicated colours, top in glass white or black, foot-rest in steel.

Structure en laminé dans les 3 couleurs indiquées, tablette en verre blanc ou noir, repose pieds en acier.

Estructura en prelaminado en los colores indicados, encimera en crystal blanco o negro, apoja pies en acero.

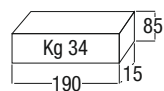
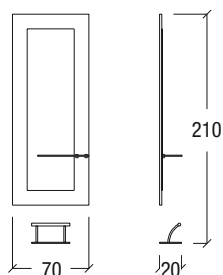

Nobilitato per struttura.

Pre-laminated for frame.

Laminé pour structure.

Prelaminado para estructura.



effetto tessuto

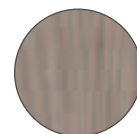

rovere

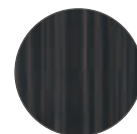

black esprit

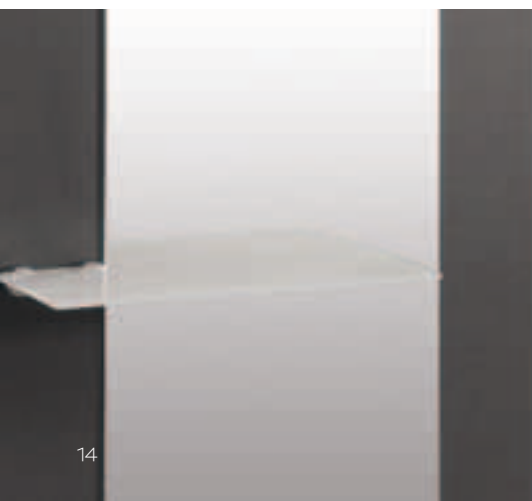



## Art. 8240

**016** codice prezzo . price code .  
code prix . código de precio

Struttura in nobilitato nei  
2 colori indicati, piano lavoro in  
vetro colorato bianco o nero,  
poggia piede alluminio fuso.

Frame in pre-laminated in the  
2 indicated colours, top in glass  
white or black, foot-rest in  
melted aluminium.

Structure en laminé dans les 2  
couleurs indiquées, tablette en  
verre blanc ou noir, repose pieds  
en aluminium fondu.

Estructura en prelaminado en  
los 2 colores indicados, encimera  
en crystal blanco o negro,  
apoya pies en aluminio.

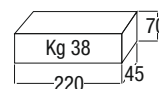
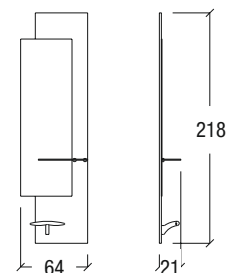

Nobilitato  
per struttura.

Pre-laminated  
for frame.

Laminé pour  
structure.

Prelaminado  
para estructura.



rovere



black esprit

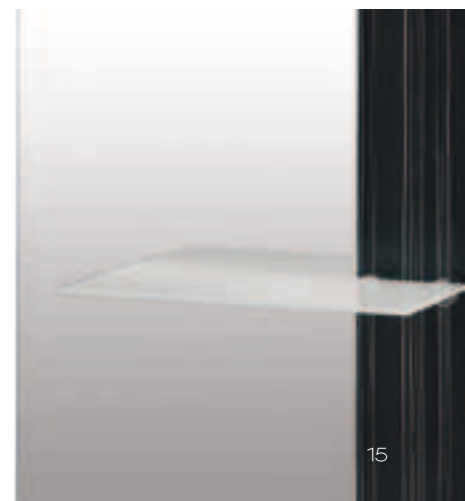

# Dot

## Art. 8216

codice prezzo . price code .  
code prix . código de precio 017

Superficie a specchio, piano lavoro  
in alluminio con predisposizione  
portaphon, poggia piede acciaio  
cromato lucido.

Mirror on all the surface, top in  
aluminium with arrangement for  
dryer holder, foot-rest in steel.

Miroir sur toute la surface, plan de  
travail en aluminium avec trou porte  
sechoir, repose pieds en acier.

Espejo completo, encimera en  
aluminio con agujero porta secador,  
apoya pies en acero cromado pulido.

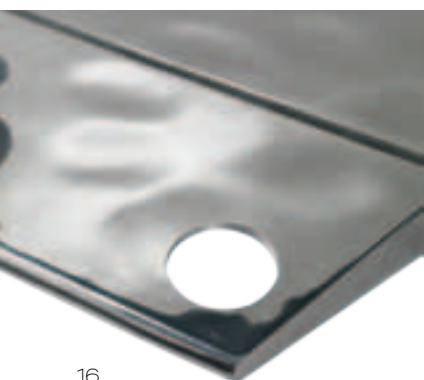
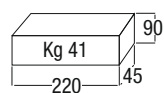
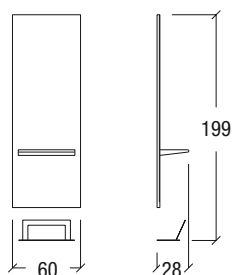

## Art. 8215

**018** codice prezzo . price code .  
code prix . código de precio

Superficie a specchio,  
piano lavoro in alluminio  
lucidato con illuminazione  
incorporata, poggia piede  
in acciaio inox.

Mirror on all surface, top in  
aluminium with light,  
foot-rest in steel.

Miroir sur toute la surface,  
plan de travail en aluminium  
avec illumination,  
repose-pied in acier.

Espejo completo, encimera  
en aluminio pulido con  
iluminación incorporada,  
apoya-pies de acero.

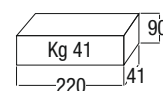
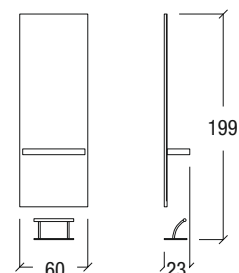

# Stripe

Art. 8217

codice prezzo . price code .  
code prix . código de precio **019**

Superficie a specchio con decorazione laterale, piano lavoro in dibond nei 3 colori indicati, poggia piedi acciaio inox.

Mirror on all the surface with decoration in one side, top in dibond in the 3 indicated colours, foot-rest in steel.

Miroir sur toute la surface avec decoration lateral, plan de travail en dibond dans les 3 couleurs indiqués, repose-pied en inox.

Superficie espejo con decoracion lateral, encimera en dibond en los 3 colores indicados, apoja-pies en acero inox.

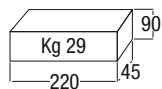
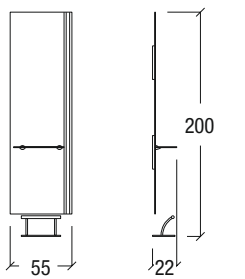

Dibond per piano lavoro.  
Dibond for shelf.  
Dibond pour tablette.  
Dibond por encimera.

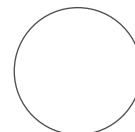

bianco



nero

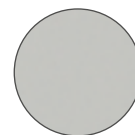

silver



postì lavoro  
styling units . coiffeuses . tocadores

# Kora

Art. 8225

**020** codice prezzo . price code .  
code prix . código de precio

Laterale in skai finitura capitonné, piano lavoro e poggia piede acciaio inox.

Lateral filet in skai capitonné, top and foot-rest in steel.

Bande laterale en skai capitonné, tablette et repose-pieds inox.

Lateral en skai capitonné, encimera y apoja pies en acero inox.

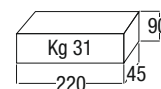
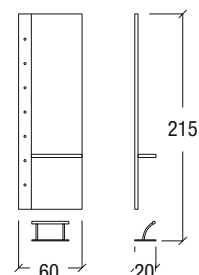

# Uma

Art. 8155

Struttura in poliuretano espanso con inserto interno in acciaio, tappezzeria in skai.

Frame in moulded polyurethane with steel frame, upholstery in skai.

Structure en polyurethane avec structure en acier, tapisserie en skai.

Estructura en polyuretano expandido con inserto interior de acero, tapiceria en skai.

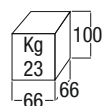
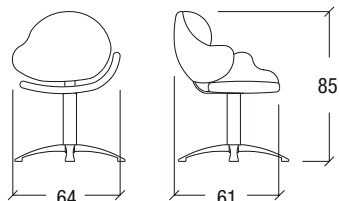

verniciato . painted  
verni . barnizado

	P70	P51	P80	P81	P30	P31
con piede with foot avec pied con pie  tappezzeria upholstery tapisserie tapiceria						
	codice prezzo . price code . code prix . código de precio					
NORMAL SKAI	[021]	[025]	[029]	[033]	[037]	[041]
SPECIAL SKAI	[022]	[026]	[030]	[034]	[038]	[042]
TOP SKAI	[023]	[027]	[031]	[035]	[039]	[043]
BICOLOR	[024]	[028]	[032]	[036]	[040]	[044]

poltrone lavoro  
rotating chairs . fauteuils de travail . sillones de trabajo

# Coconut

Art. 8130



Struttura in poliuretano  
espanso con inserto  
interno in acciaio,  
tappezzeria in skai.

Frame in moulded  
expanded polyurethane  
with steel frame,  
upholstery in skai.

Structure en  
polyurethane avec inside  
structure en acier,  
tapisserie en skai.

Estructura en  
polyuretano expandido  
con inserido interior de  
acero, tapiceria en skai.

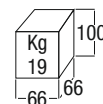
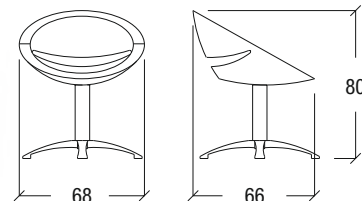

con piede with foot avec pied con pie	P70	P51	P80	P81
tappezzeria upholstery tapisserie tapiceria				
	codice prezzo . price code . code prix . código de precio			
NORMAL SKAI	045	049	053	057
SPECIAL SKAI	046	050	054	058
TOP SKAI	047	051	055	059
BICOLOR	048	052	056	060



# Meg

Art. 8145

Struttura in poliuretano espanso con inserto interno in acciaio, tappezzeria in skai.

Frame in moulded expanded polyurethane with steel frame, upholstery in skai.

Structure en polyurethane avec structure en acier, tapisserie en skai.

Estructura en polyuretano expandido con inserto interior de acero, tapiceria en skai.

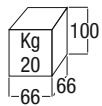
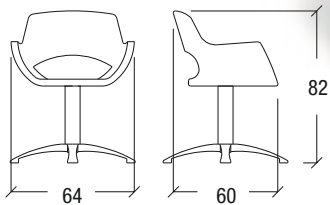

verniciato . painted  
verni . barnizado

	P70	P51	P80	P81	P30	P31
con piede with foot avec pied con pie						
tappezzeria upholstery tapisserie tapiceria						
	codice prezzo . price code . code prix . código de precio					
NORMAL SKAI	[061]	[065]	[069]	[073]	[077]	[081]
SPECIAL SKAI	[062]	[066]	[070]	[074]	[078]	[082]
TOP SKAI	[063]	[067]	[071]	[075]	[079]	[083]
BICOLOR	[064]	[068]	[072]	[076]	[080]	[084]



poltrone lavoro  
rotating chairs . fauteuils de travail . sillones de trabajo

# Apple

Art. 8136



Struttura in acrilico,  
cuscino in skai.

Frame in acrylic,  
seat in skai.

Structure en acrilic,  
assise en skai.

Estructura en  
acrílico, asiento  
en skai.

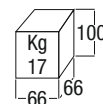
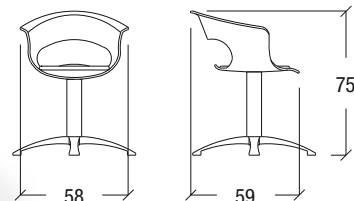

con piede with foot avec pied con pie	P70	P51	P80	P81
tappezzeria upholstery tapisserie tapiceria				
	codice prezzo . price code . code prix . código de precio			
NORMAL SKAI	085	088	091	094
SPECIAL SKAI	086	089	092	095
TOP SKAI	087	090	093	096



# Musa

Art. 8161

Struttura in multistrato di faggio, imbottitura in poliuretano espanso.

Frame in multi-ply beech, covered by moulded polyurethane, upholstery in skai.

Structure multicouche de hêtre, rembourrage en polyurethane, tapisserie en skai.

Estructura en multicapa de haya, relleno en poliuretano expandido.

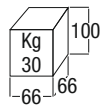
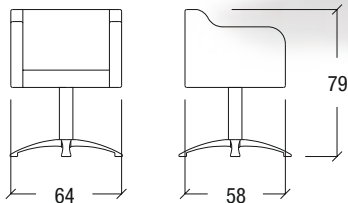

verniciato . painted  
verni . barnizado

	P70	P51	P98	P99	P40	P41
con piede with foot avec pied con pie  tappezzeria upholstery tapisserie tapiceria						
	codice prezzo . price code . code prix . código de precio					
NORMAL SKAI	097	101	105	109	113	117
SPECIAL SKAI	098	102	106	110	114	118
TOP SKAI	099	103	107	111	115	119
BICOLOR	100	104	108	112	116	120

poltrone lavoro  
rotating chairs . fauteuils de travail . sillones de trabajo

# Winona

Art. 8171







Struttura in poliuretano espanso con inserto in acciaio, tappezzeria in skai.

Frame in moulded expanded polyurethane with steel frame, upholstery in skai.

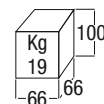
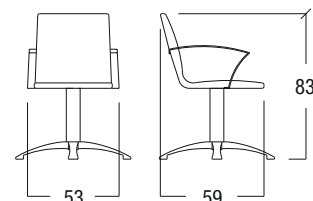
Structure en polyurethane avec inside structure en acier, tapisserie en skai.

Estructura en poliuretano expandido con inserido interior de acero, tapiceria en skai.



con piede with foot avec pied con pie	P70	P51	P80	P81
tappezzaria upholstery tapisserie tapiceria				
	codice prezzo . price code . code prix . código de precio			
NORMAL SKAI	121	124	127	130
SPECIAL SKAI	122	125	128	131
TOP SKAI	123	126	129	132



# Kelly

Art. 8167

Struttura in multistrato di faggio, imbottitura in poliuretano espanso, braccioli in tubolare d'acciaio finitura lucida.

Frame in multi-ply beech, covered by moulded polyurethane, upholstery in skai, armrest in chromed glossy steel.

Structure pan multicouche, hêtre rembourrage en polyurethane, tapisserie en skai, accoudoirs acier chromé brillant.

Estructura en multicapa de haya, relleno en polyuretano expandido, brazos de acero pulido.

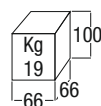
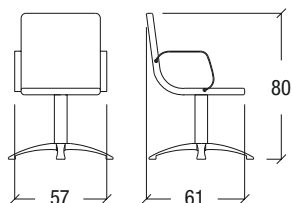

con piede with foot avec pied con pie	P70	P51	P98	P99
tappezzeria upholstery tapisserie tapiceria				
	codice prezzo . price code . code prix . código de precio			
NORMAL SKAI	133	136	139	142
SPECIAL SKAI	134	137	140	143
TOP SKAI	135	138	141	144

poltrone lavoro  
rotaring chairs . fauteuils de travail . sillones de trabajo

# Dolcenera

Art. 8153

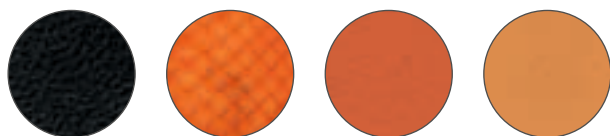

35

107

102

101

Colori skai. Skai colours. Couleurs skai. Colores skai.





Struttura in poliuretano espanso con inserto interno in acciaio, tappezzeria in skai nei 4 colori indicati.

Frame in moulded expanded polyurethane with steel frame, upholstery in skai in the 4 indicated colours.

Structure en polyurethane avec structure en acier, tapisserie en skai dans les 4 couleurs indiqués.

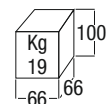
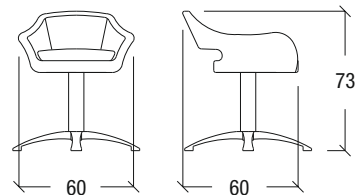
Estructura en poliuretano expandido con inserto interior de acero, tapiceria en skai en los 4 colores indicados.



con piede with foot avec pied con pie	P70	P51
		
codice prezzo . price code . code prix . código de precio		
	145	146



# Anouk

Art. 8124

Struttura in metallo verniciato, braccioli in piatto d'acciaio cromato lucido.

Frame in painted metal upholstery in skai, chromed glossy steel armrests

Structure en metal verni, tapisserie en skai, accoudoirs en acier chromé brillant.

Estructura en metal barnizado, brazos en acero cromado pulido.

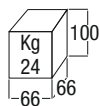
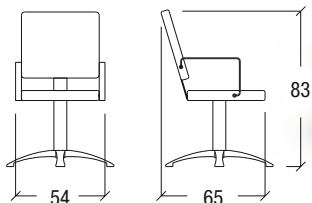

con piede with foot avec pied con pie  tappezzeria upholstery tapisserie tapiceria	P70	P51	P80	P81	P98	P99
     						
	codice prezzo . price code . code prix . código de precio					
NORMAL SKAI	147	150	153	156	159	162
SPECIAL SKAI	148	151	154	157	160	163
TOP SKAI	149	152	155	158	161	164

poltrone lavoro  
rotating chairs . fauteuils de travail . sillones de trabajo

# Trafalgar

Art. 8175







Struttura in multistrato di faggio, imbottitura in poliuretano espanso.

Frame in multi-ply beech, covered by moulded polyurethane, upholstery in skai.

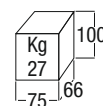
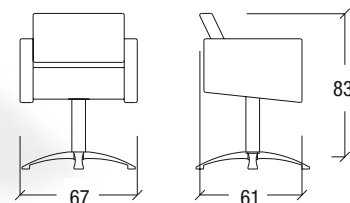
Structure par multicouche hêtre rembourrage en polyurethane, tapisserie en skai.

Estructura en multicapa de haya, relleno de poliuretano expandido, tapicería en skai.



con piede with foot avec pied con pie	P70	P51	P98	P99
tappezzeria upholstery tapisserie tapicería				
	codice prezzo . price code . code prix . código de precio			
NORMAL SKAI	165	169	173	177
SPECIAL SKAI	166	170	174	178
TOP SKAI	167	171	175	179
BICOLOR	168	172	176	180



# Cube

Art. 8100

Struttura metallo verniciato,  
tappezzeria in skai.

Frame in painted metal,  
upholstery in skai.

Structure en metal verni,  
tapisserie en skai.

Estructura en metal  
branzado, tapiceria en skai.

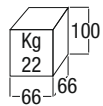
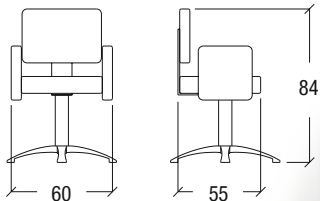

	P70	P51	P80	P81	P98	P99
con piede with foot avec pied con pie  tappezzeria upholstery tapisserie tapiceria						
	codice prezzo . price code . code prix . código de precio					
NORMAL SKAI	181	184	187	190	193	196
SPECIAL SKAI	182	185	188	191	194	197
TOP SKAI	183	186	189	192	195	198



poltrone lavoro  
rotating chairs . fauteuils de travail . sillones de trabajo

# Glam

Art. 8105







Struttura metallo  
verniciato,  
tappezzeria in skai.

Frame in painted  
metal, upholstery  
in skai.

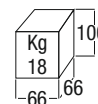
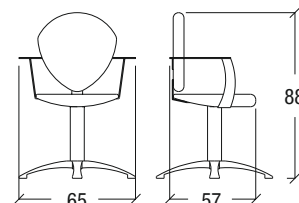
Structure en metal  
verni, tapisserie  
en skai.

Estructura en metal  
branizado, tapiceria  
en skai.



con piede with foot avec pied con pie	P70	P51	P80	P81
tappezzeria upholstery tapisserie tapiceria				
	codice prezzo . price code . code prix . código de precio			
NORMAL SKAI	199	202	205	208
SPECIAL SKAI	200	203	206	209
TOP SKAI	201	204	207	210



# Sid

## Art. 8050

codice prezzo . price code .  
code prix . código de precio

NORMAL SKAI [211]

SPECIAL SKAI [212]

TOP SKAI [213]

Struttura in piatto d'acciaio  
verniciato, lavello bianco  
basculante, tappezzeria  
in skai.

Frame in painted steel,  
tilting white basin,  
upholstery in skai.

Structure en acier verni,  
cuvette blanc basculante,  
tapisserie en skai.

Estructura en acero pintado,  
pica blanca basculante,  
tapiceria en skai.

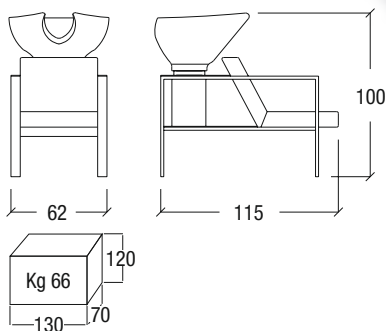

## Utility

### Art. 8001

[317] codice prezzo . price code .  
code prix . código de precio



## Utility

### Art. 8002

codice prezzo . price code .  
code prix . código de precio **317**



### Art. 8030

codice prezzo . price code .  
code prix . código de precio

**214** NORMAL SKAI

**215** SPECIAL SKAI

**216** TOP SKAI

Struttura in acciaio  
verniciato, lavello  
bianco basculante,  
tappezzeria in skai.

Frame in painted steel,  
tilting white basin,  
upholstery in skai.

Structure en acier  
verni, cuvette blanc  
basculante, tapisserie  
en skai.

Estructura en acero  
pintado, pica blanca.

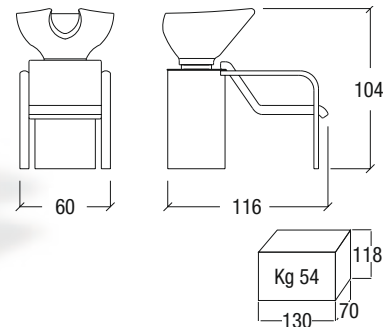

# Anouk wash

## Art. 8009

codice prezzo . price code .  
code prix . código de precio

NORMAL SKAI **217**

SPECIAL SKAI **218**

TOP SKAI **219**

Lavaggio singolo in metallo verniciato, lavello basculante, tappezzeria in skai.

Single wash unit, frame in painted metal, tilting basin, upholstery in skai.

Bac individuel, structure en metal verni, cuvette basculante, tapisserie en skai.

Lavacabeza individual, estructura en metal barnizado, pica basculante, tapiceria en skai.

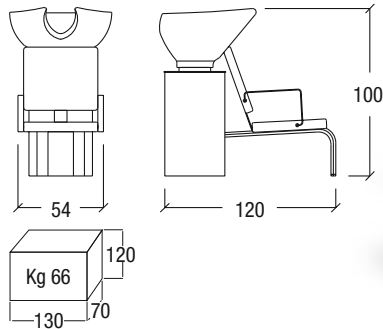

## Utility

### Art. 8002

codice prezzo . price code .  
code prix . código de precio **317**



# Meg Wash

Art. 8022

codice prezzo . price code .  
code prix . código de precio

220 NORMAL SKAI

221 SPECIAL SKAI

222 TOP SKAI

223 BICOLOR

Struttura in materiale poliuretano  
colore nero, lavello bianco  
basculante, tappezzeria in skai.

Frame in polyurethane material  
black, tilting white basin,  
upholstery in skai.

Structure en materiel  
polyurethane noir, cuvette blanc  
basculante, tapisserie en skai.

Estructura de material  
polyuretano negro,  
lavabo blanco basculante,  
tapiceria en skai.

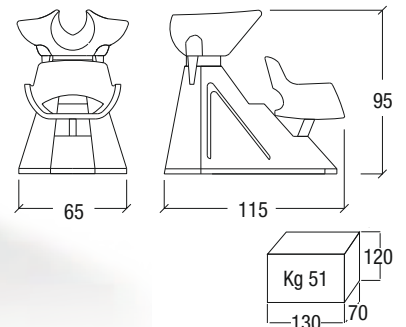

## Utility

Art. 8003

codice prezzo . price code .  
code prix . código de precio **318**



# Coconut Wash

## Art. 8021

codice prezzo . price code .  
code prix . código de precio

NORMAL SKAI **224**

SPECIAL SKAI **225**

TOP SKAI **226**

BICOLOR **227**

Struttura in materiale poliuretano colore nero, lavello bianco basculante, tappezzeria in skai.

Frame in polyurethane material black, tilting white basin, upholstery in skai.

Structure en matériel polyuréthane noir, cuvette blanc basculante, tapisserie en skai.

Estructura de material poliuretano negro, lavabo blanco basculante, tapicería en skai.

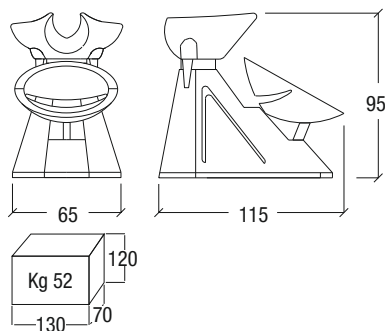

## Utility

### Art. 8003

codice prezzo . price code . **318**  
code prix . código de precio



# Spongy

Art. 8015

codice prezzo . price code .  
code prix . código de precio

**228** NORMAL SKAI

**229** SPECIAL SKAI

**230** TOP SKAI

**231** BICOLOR

Lavaggio singolo in metallo verniciato, lavello basculante, tappezzeria in skai.

Single wash unit, frame in painted metal, tilting basin, upholstery in skai.

Bac individuel, structure en metal verni, cuvette basculante, tapisserie en skai.

Lavacabeza individual, estructura en metal barnizado, pica basculante, tapiceria en skai.

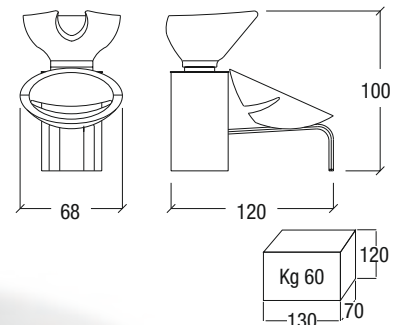

## Utility

Art. 8002

codice prezzo . price code .  
code prix . código de precio **317**



# Jam

## Art. 8013

codice prezzo . price code .  
code prix . código de precio

NORMAL SKAI **232**

SPECIAL SKAI **233**

TOP SKAI **234**

BICOLOR **235**

Lavaggio singolo in metallo verniciato, lavello basculante, tappezzeria in skai.

Single wash unit, frame in painted metal, tilting basin, upholstery in skai.

Bac individuel, structure en metal verni, cuvette basculante, tapisserie en skai.

Lavacabeza individual, estructura en metal barnizado, pica basculante, tapiceria en skai.

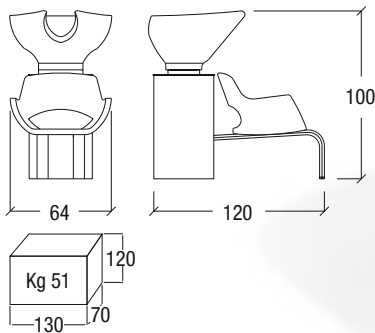

## Utility

### Art. 8002

codice prezzo . price code .  
code prix . código de precio **317**





# Cube Wash

**Art. 8000**

codice prezzo . price code .  
code prix . código de precio

**236** NORMAL SKAI

**237** SPECIAL SKAI

**238** TOP SKAI



Lavaggio singolo in metallo verniciato, lavello basculante, tappezzeria in skai.

Single wash unit, frame in painted metal, tilting basin, upholstery in skai.

Bac individuel, structure en metal verni, cuvette basculante, tapisserie en skai.

Lavacabeza individual, estructura en metal barnizado, pica basculante, tapiceria en skai.

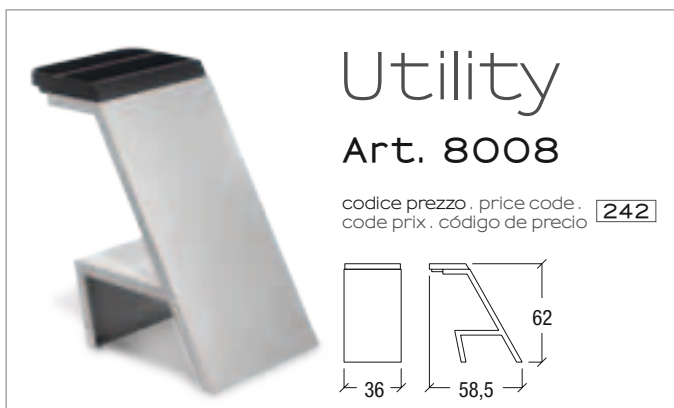
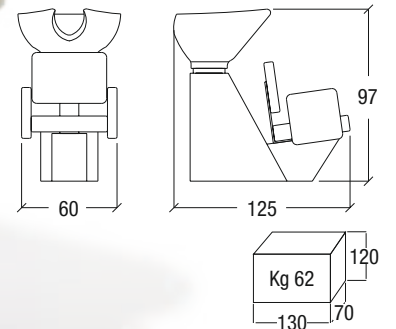

# Glam Wash

lavaggi  
wash systems . bacs de lavages . lavacabezas

## Art. 8005

codice prezzo . price code .  
code prix . código de precio

NORMAL SKAI **239**

SPECIAL SKAI **240**

TOP SKAI **241**

Lavaggio singolo in metallo verniciato, lavello basculante, tappezzeria in skai.

Single wash unit, frame in painted metal, tilting basin, upholstery in skai.

Bac individuel, structure en metal verni, cuvette basculante, tapisserie en skai.

Lavacabeza individual, estructura en metal barnizado, pica basculante, tapiceria en skai.

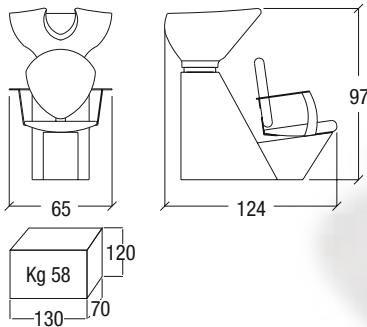

## Utility

### Art. 8008

**242** codice prezzo . price code .  
code prix . código de precio

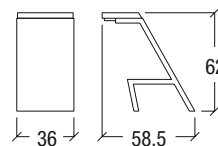

service

# Style

Art. 8250

**243** codice prezzo . price code .  
code prix . código de precio



Struttura in nobilitato silver grey, frontale nei 3 colori indicati.

Frame in pre-laminated silver grey, frontal in the 3 indicated colours.

Structure en laminé silver grey, frontal dans les 3 couleurs indiquées.

Estructura de prelamado silver grey, frontal en los 3 colores indicados.

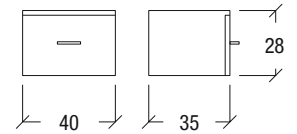

# Coconut waiting

## Art. 8302

codice prezzo . price code .  
code prix . código de precio

NORMAL SKAI **244**

SPECIAL SKAI **245**

TOP SKAI **246**

BICOLOR **247**

Struttura in poliuretano  
espanso con inserto interno  
in acciaio, tappezzeria in skai.

Frame in moulded expanded  
polyurethane with steel  
frame, upholstery in skai.

Structure en polyurethane  
avec inside structure en acier,  
tapisserie en skai.

Estructura en poliuretano  
expandido con inserto interior  
de acero, tapicería en skai.

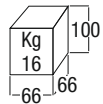
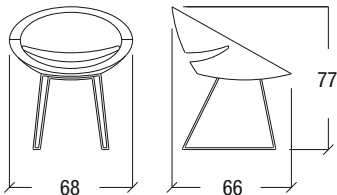

Portacasco. Dryer-holder.  
Porte casque. Portacasco.

## Art. 8303

codice prezzo . price code .  
code prix . código de precio

**248** NORMAL SKAI

**249** SPECIAL SKAI

**250** TOP SKAI

**251** BICOLOR

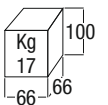
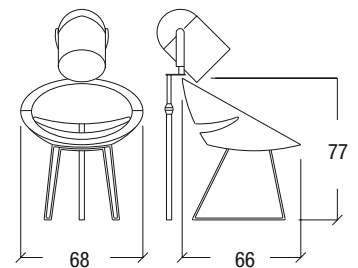

poltrone attesa  
waiting chairs . fauteuils d'attente . sillones de espera

# Sweet

## Art. 8300

codice prezzo . price code .  
code prix . código de precio

**252** NORMAL SKAI

**253** SPECIAL SKAI

**254** TOP SKAI

**255** BICOLOR



Imbottitura in poliuretano espanso, struttura interna in acciaio, tappezzeria in skai.

Frame in moulded expanded polyurethane with steel frame, upholstery in skai.

Structure en polyurethane avec inside structure en acier, tapisserie en skai.

Relleno en poliuretano expandido, estructura interior en acero, tapiceria en skai.

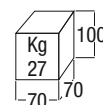
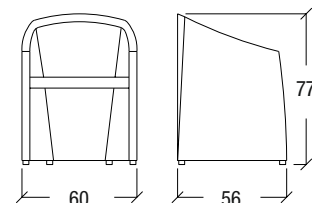

Portacasco. Dryer-holder.  
Porte casque. Portacasco.

## Art. 8301

codice prezzo . price code .  
code prix . código de precio

NORMAL SKAI **256**

SPECIAL SKAI **257**

TOP SKAI **258**

BICOLOR **259**

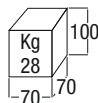
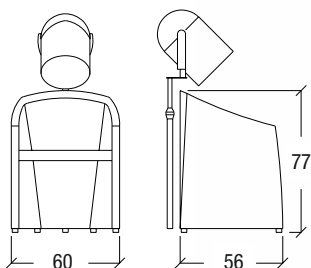

# Feel

## Art. 8310

codice prezzo . price code .  
code prix . código de precio

NORMAL SKAI **260**

SPECIAL SKAI **261**

TOP SKAI **262**

Struttura in  
agglomerato,  
imbottitura in  
poliuretano espanso,  
tappezzeria in skai.

Frame in agglomerate  
wood, padding  
in polyurethane,  
upholstery in skai.

Structure en bois  
aggloméré, rembourrage  
en polyurethane,  
tapisserie en skai.

Estructura de madera,  
relleno en poliuretano  
espanso, tapiceria  
en skai.

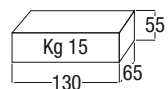
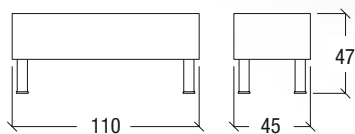

poltrone attesa  
waiting chairs . fauteuils d'attente . sillones de espera



# Single

## Art. 8305

codice prezzo . price code .  
code prix . código de precio

**263** NORMAL SKAI

**264** SPECIAL SKAI

**265** TOP SKAI

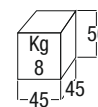
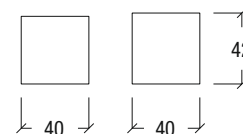

Struttura in agglomerato,  
imbottitura in poliuretano  
espanso, tappezzeria in skai.

Frame in agglomerate wood,  
padding in polyurethane,  
upholstery in skai.

Structure en bois aggloméré,  
rembourrage en polyurethane,  
tapisserie en skai.

Estructura de madera, relleno  
en poliuretano espanso,  
tapiceria en skai.



# Round

## Art. 8315

codice prezzo . price code .  
code prix . código de precio

**266** NORMAL SKAI

**267** SPECIAL SKAI

**268** TOP SKAI

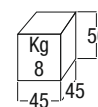
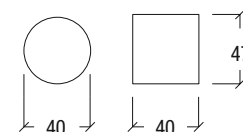

# Bauhaus Desk

## Art. 8413

codice prezzo . price code .  
code prix . código de precio **269**

Dibond per decorazione frontale.

Dibond for frontal decoration.

Dibond pour decoration frontal.

Dibond para frontal.

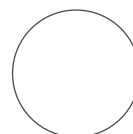

bianco



nero

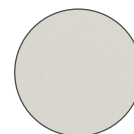

silver

Struttura in nobilitato nei  
5 colori indicati, decoro  
frontale in dibond nei 3 colori  
indicati con specchio inserito.

Frame in pre-laminated in the  
5 colours indicated, frontal  
decoration in dibond in the 3  
indicated colours with mirror.

Structure in laminé dans les 5  
couleurs indiquées, décoration  
frontal en dibond dans les  
3 couleurs indiquées, miroir  
incorporé.

Estructura en pre-laminado  
en los 5 colores indicados,  
frontal en dibond en los 3  
colores indicados con  
espejo frontal.

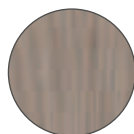
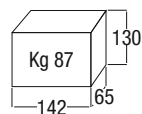
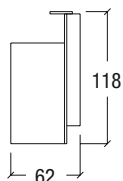
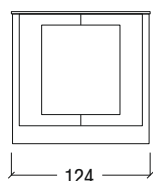

rovere

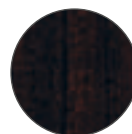

wengé

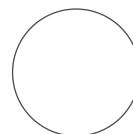

bianco lucido



nero lucido

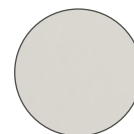

silver grey

Nobilitato per struttura. Pre-laminated for frame.  
Laminé pour structure. Prelaminado para estructura.



tavoli cassa  
cash register tables . tables caisse . receptiones

# J-LO Desk

Art. 8415

270 codice prezzo . price code .  
code prix . código de precio



Struttura in nobilitato  
nei 5 colori indicati,  
frontale in skai con  
finitura capitonnè.

Frame in pre-laminated  
in the 5 indicated  
colours, frontal in skai  
capitonnè.

Structure en laminé  
dans les 5 couleurs  
indiquées, frontal en  
skai capitonnè.

Estructura en  
prelaminado en los  
5 colores indicados,  
frontal en skai  
capitonnè.

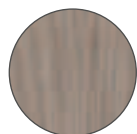
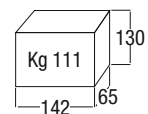
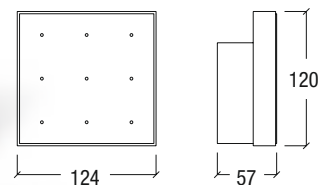

rovere



wengé

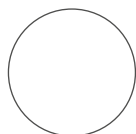

bianco lucido



nero lucido

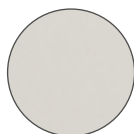

silver grey

Nobilitato per struttura. Pre-laminated for frame.  
Laminé pour structure. Prelaminado para estructura.



# Amy

## Art. 8411

codice prezzo . price code .  
code prix . código de precio **271**

Struttura in nobilitato nei  
5 colori indicati, cornici  
decorative di colore bianco o  
nero, frontale a specchio.

Frame in pre-laminated in  
the 5 indicated colours,  
decorative cornices in wood  
white or black, frontal mirror.

Structure en laminé dans les  
5 couleurs indiquées, cornices  
decoratives en bois blanc ou  
noir, miroir frontal.

Estructura en prelaminado  
en los 5 colores indicados,  
marcos decorativos blancos  
o negros.

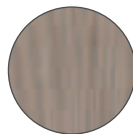
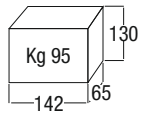
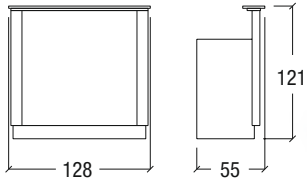

rovere

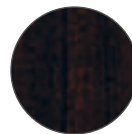

wengé

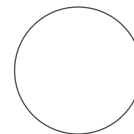

bianco lucido

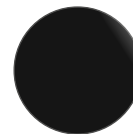

nero lucido

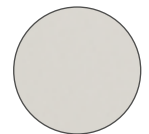

silver grey

Nobilitato per struttura. Pre-laminated for frame.  
Laminé pour structure. Prelaminado para estructura.

tavoli cassa  
cash register tables . tables caisse . receptiones

# Luminol

Art. 8414

272 codice prezzo . price code .  
code prix . código de precio



Struttura in nobilitato  
nei 5 colori indicati,  
illuminazione incorporata.

Frame in pre-laminated in  
the 5 indicated colours,  
lighting incorporated.

Structure en laminé dans  
les 5 couleurs indiquées,  
illumination incorporé.

Estructura en prelamonado  
en los 5 colores indicados,  
iluminacion incorporada.

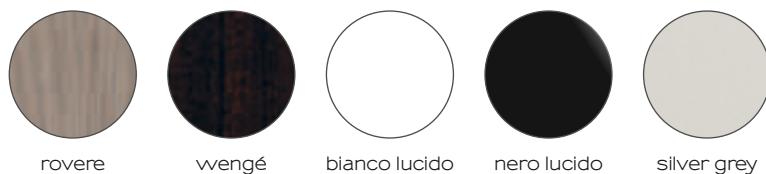
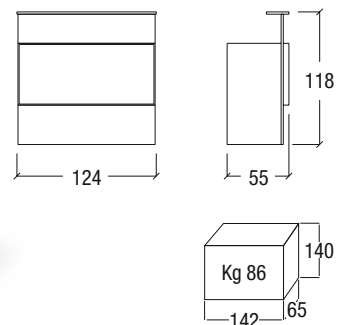

rovere

wengé

bianco lucido

nero lucido

silver grey

Nobilitato per struttura. Pre-laminated for frame.  
Laminé pour structure. Prelaminado para estructura.



# Britney

## Art. 8412

codice prezzo . price code .  
code prix . código de precio **273**

Struttura in nobilitato nei  
5 colori indicati, frontale  
a specchio.

Frame in pre-laminated in  
the 5 indicated colours,  
frontal mirror.

Structure en laminé dans  
les 5 couleurs indiquées,  
miroir frontal.

Estructura en prelaminado  
en los 5 colores indicados,  
espejo frontal.

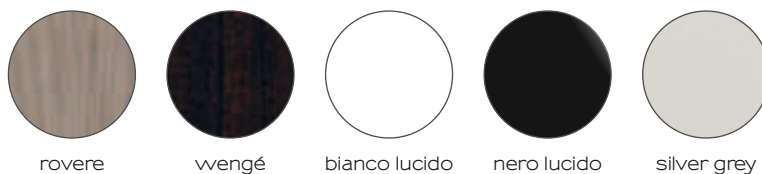
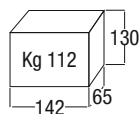
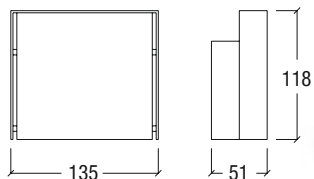

rovere

wengé

bianco lucido

nero lucido

silver grey

Nobilitato per struttura. Pre-laminated for frame.  
Laminé pour structure. Prelaminado para estructura.

tavoli cassa  
cash register tables . tables caisse . receptiones

# Flat Light

Art. 8401

274 codice prezzo . price code .  
code prix . código de precio

Struttura in nobilitato  
nei 2 colori indicati,  
illuminazione incorporata.

Frame in pre laminated in  
the 2 indicated colours,  
lighting incorporated.

Structure en laminé dans  
les 2 couleurs indiquées,  
illumination incorporé.

Estructura en pre laminado  
en los 2 colores indicados,  
iluminacion incorporada.

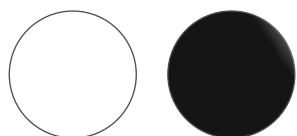
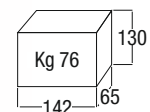
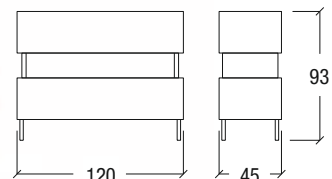

bianco lucido    nero lucido

Nobilitato per struttura. Pre-laminated for frame.  
Laminé pour structure. Prelaminado para estructura.



# Spice

## Art. 8410

codice prezzo . price code .  
code prix . código de precio **275**

Struttura in nobilitato  
nei 5 colori indicati,  
illuminazione incorporata..

Frame in pre-laminated in  
the 5 indicated colours,  
lighting incorporated.

Structure en laminé dans  
les 5 couleurs indiquées,  
illumination incorporée.

Estructura en prelaminado  
en los 5 colores indicados,  
iluminación incorporada.

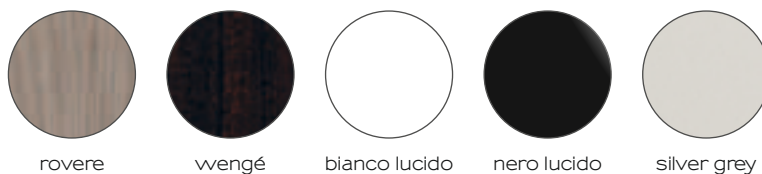
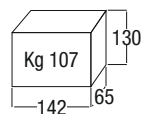
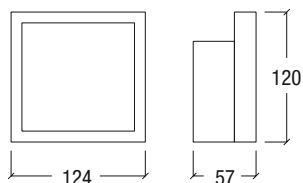

rovere

wengé

bianco lucido

nero lucido

silver grey

Nobilitato per struttura. Pre-laminated for frame.  
Laminé pour structure. Prelaminado para estructura.

tavoli cassa  
cash register tables . tables caisse . receptiones

# Spring

Art. 8420

276 codice prezzo . price code .  
code prix . código de precio



Supporto in metallo verniciato, struttura in nobilitato nei 2 colori indicati, frontale in skai capitonné.

Support in painted metal frame in pre-laminated in the 2 indicated colours, frontal in skai capitonné.

Support en metal verni, structure en laminé dans les 2 couleurs indiquées, frontal en skai capitonné.

Suporte en metal barnizado, estructura en prelaminado en los 2 colores indicados, frontal en skai capitonné.

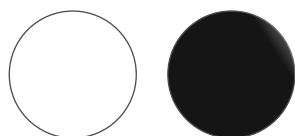
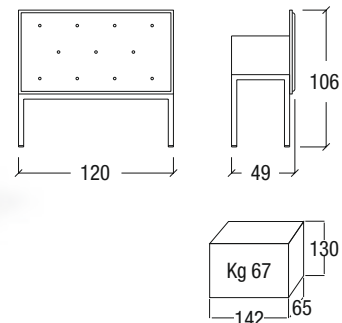

bianco lucido    nero lucido

Nobilitato per struttura. Pre-laminated for frame.  
Laminé pour structure. Prelaminado para estructura.



# Dada Expo

## Art. 8604

codice prezzo . price code .  
code prix . código de precio **277**

Struttura in nobilitato 478 grey,  
sportelli e fondale in nobilitato nei  
3 colori indicati.

Frame in pre-laminated 478 grey,  
doors and back in pre-laminated in  
the 3 indicated colours.

Structure en laminé 478 grey,  
portières et panneau expositif en  
laminé dans les 3 couleurs indiquées.

Estructura en prelaminado 478 grey,  
ventanillas y espalda en prelaminado  
en los 3 colores indicados.

## Art. 8606 codice prezzo . price code . code prix . código de precio **278**

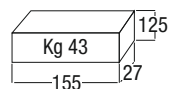
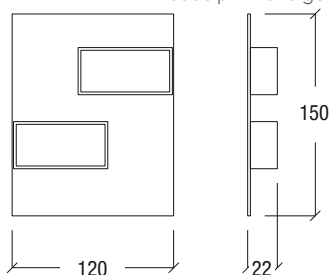

## Art. 8733 codice prezzo . price code . code prix . código de precio **279**

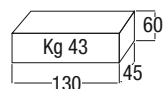
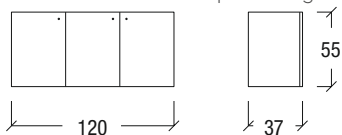

effetto tessuto



nero lucido

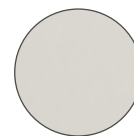

silver grey

Colori per sportelli e fondale. Colours for doors and back.  
Couleurs pour portières et panneau expositif. Colores por ventanillas y espalda.



# Kimera Expo

Art. 8602

280 codice prezzo . price code .  
code prix . código de precio

Struttura in nobilitato nei  
3 colori indicati, cornici  
decorative di colore  
bianco o nero.

Frame in pre-laminated in  
the 3 indicated colours,  
decorative cornices in  
wood white or black.

Structure en laminé dans  
les 3 couleurs indiquées,  
cornices decorative en  
bois blanc o noir.

Estructura en prelamonado  
en los 3 colores indicados,  
marcos decorativos  
blancos o negros.

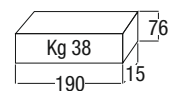
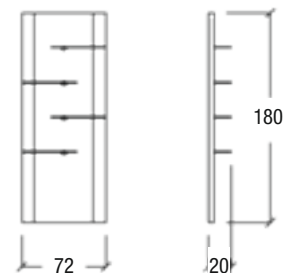

bianco lucido    nero lucido    silver grey

Nobilitato per struttura. Pre-laminated for frame.  
Laminé pour structure. Prelaminado para estructura.



# Reality Expo

## Art. 8603

codice prezzo . price code .  
code prix . código de precio **281**

Struttura in nobilitato colore  
effetto tessuto, piani in vetro.

Frame in pre-laminated colour  
"effetto tessuto", shelves in glass.

Structure en laminé couleur  
"effet tissu", tablettes en  
verre.

Estructura en prelaminado color  
"efecto tejido", encimeras de  
crystal.

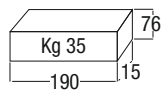
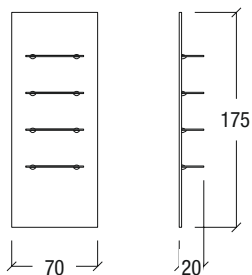

## Art. 8605

**282** codice prezzo . price code .  
code prix . código de precio

Pannello in nobilitato  
silver grigio con  
pianetti in plexiglass.

Panel in pre-laminated  
silver grey with tops  
in plexiglass.

Panneau en laminé  
silver grey avec  
tablette en plexiglass.

Panel de prelaminado  
silver gris con  
estantes de plexiglass.

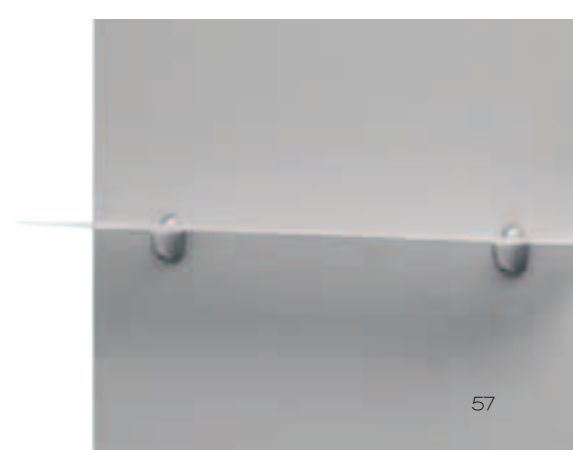
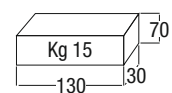
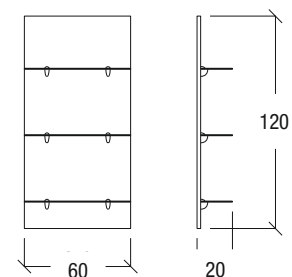

# Mobili Servizio

Struttura sospesa in nobilitato 478 grey, sportelli in nobilitato nei 3 colori indicati.

Frame suspended in pre-laminated 478 grey, doors in pre-laminated in the 3 indicated colours.

Structure suspendue en laminé 478 grey, portières en laminé dans les 3 couleurs indiquées.

Estructura en prelaminado 478 grey, ventanillas en prelaminado en los 3 colores indicados.

## Art. 8730

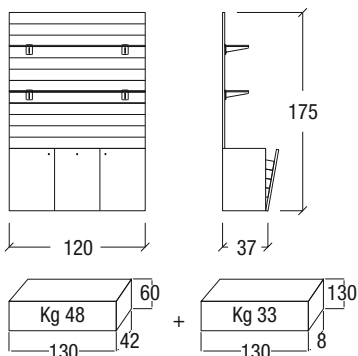

## Art. 8738

codice prezzo . price code . code prix . código de precio **285**

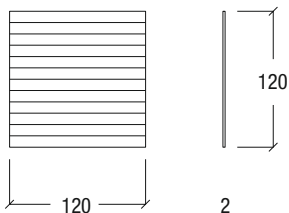

## Art. 8740

codice prezzo . price code . code prix . código de precio **287**

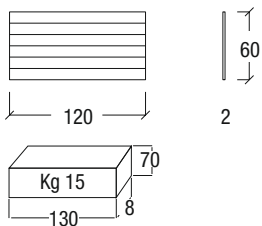

## Art. 8730

codice prezzo . price code . code prix . código de precio **283**

## Art. 8739

codice prezzo . price code . code prix . código de precio **286**

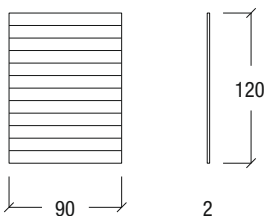

## Art. 8741

codice prezzo . price code . code prix . código de precio **287**

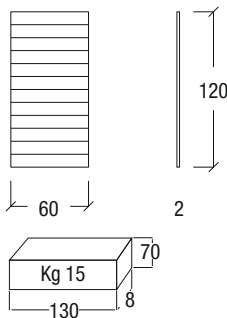

## Art. 8742

codice prezzo . price code . code prix . código de precio **288**

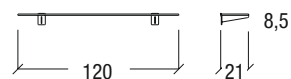

Nobilitato per sportelli.

Pre-laminated for doors.

Laminé pour portières.

Prelaminado para ventanillas.



effetto tessuto



nero lucido

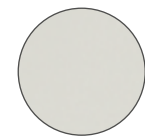

478 grey



**Art. 8731**

**284** codice prezzo . price code .  
code prix . código de precio

**Art. 8731**

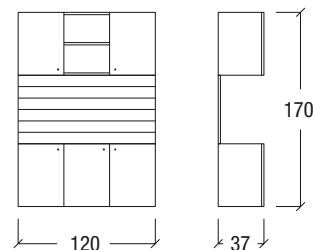

**Art. 8737**

**279** codice prezzo . price code .  
code prix . código de precio

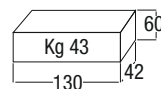
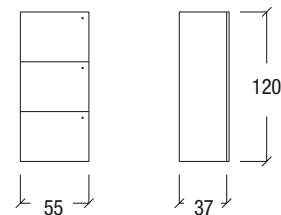

**Art. 8733**

**279** codice prezzo . price code .  
code prix . código de precio

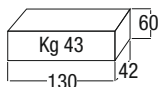
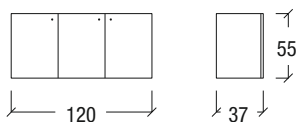

**Art. 8734**

**289** codice prezzo . price code .  
code prix . código de precio

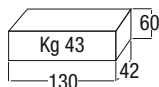
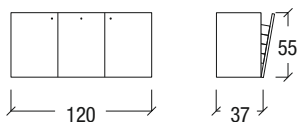

**Art. 8735**

**290** codice prezzo . price code .  
code prix . código de precio

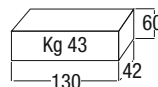
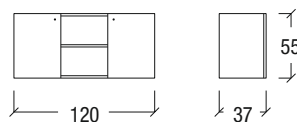

**Art. 8736**

**291** codice prezzo . price code .  
code prix . código de precio

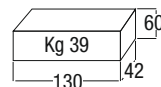
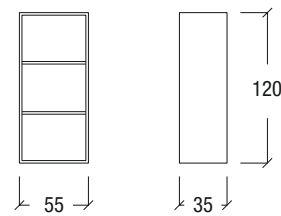

# Mobili Servizio

Struttura in nobilitato silver grey, sportelli in laminato nei 2 colori indicati.

Frame in pre-laminated silver grey, doors in plastic laminated in the 2 indicated colours.

Structure en laminé silver grey, portieres en stratifié dans les 2 couleurs indiquées.

Estructura de prelaminado silver grey, ventanillas de laminado en los 2 colores indicados.

## Art. 8725

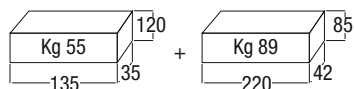
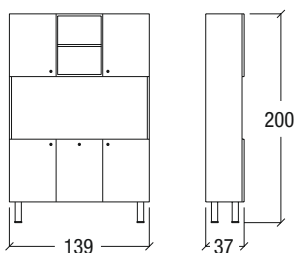

## Art. 8720

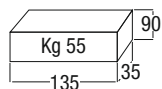
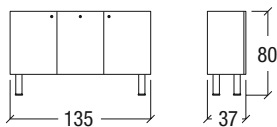

## Art. 8725

codice prezzo . price code . code prix . código de precio **292**



## Art. 8720

codice prezzo . price code . code prix . código de precio **293**



## Art. 8710

296 codice prezzo . price code .  
code prix . código de precio

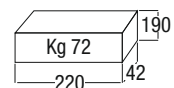
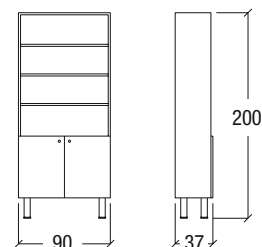

## Art. 8715

297 codice prezzo . price code .  
code prix . código de precio

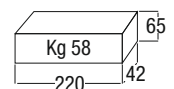
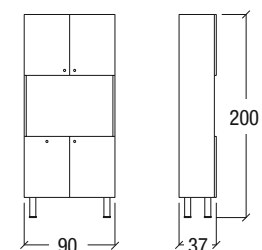

## Art. 8705

295 codice prezzo . price code .  
code prix . código de precio

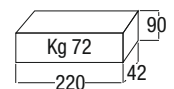
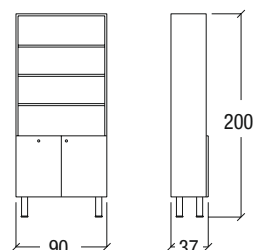

## Art. 8700

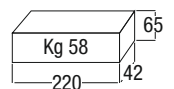
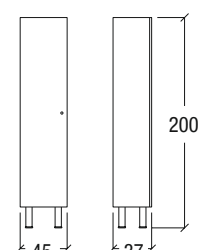

## Art. 8700

294 codice prezzo . price code .  
code prix . código de precio

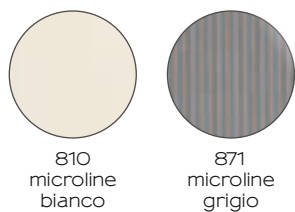

Laminati per sportelli. Plastic laminated for doors.  
Stratifiés pour portières. Laminado para ventanillas.

# Bijou

## Art. 10070/N

codice prezzo . price code .  
code prix . código de precio **298**

Tavolo manicure con aspiratore, in nobilitato nei 2 colori indicati e alluminio punzonato e spazzolato.

Manicure table with nail dust collector, in pre-laminated in the 2 indicated colours and stamped and brushed aluminium.

Table manicure avec aspirateur, en laminé dans les 2 couleurs indiquées et aluminium poconné.

Mesa de manicure con aspirador, en prelaminado en los 2 colores indicados y aluminio cepillado.

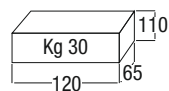
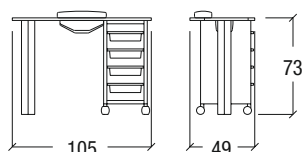

Nobilitato. Pre-laminated.  
Laminé. Prelaminado.

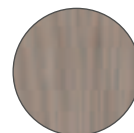

rovere

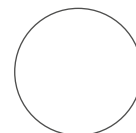

bianco lucido



Cuscino poggiamani.  
Coussin appui main.  
Handrest cushion.  
Apoya mano.

### Art. 10082/N

codice prezzo . price code .  
code prix . código de precio **305**



### Art. 10085/N

codice prezzo . price code .  
code prix . código de precio **302**



### Art. 10095/N

codice prezzo . price code .  
code prix . código de precio **303**



## Art. 10080/N

**299** codice prezzo . price code .  
code prix . código de precio

Tavolo manicure in  
nobilitato nei  
2 colori indicati.

Manicure table in  
prelaminated in the  
2 indicated colours.

Table de manicure en  
laminé dans les  
2 couleurs indiquées.

Mesa de manicure en  
prelaminado en los  
2 colores indicados.

Porta smalti.  
Nail polish holder.  
Porte produits.  
Porta productos.

### Art. 10081/N

codice prezzo . price code . **319**  
code prix . código de precio



Cuscino poggiamani.  
Coussin appui main.  
Handrest cushion.  
Apoja mano.

### Art. 10082/N

codice prezzo . price code . **305**  
code prix . código de precio

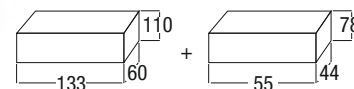
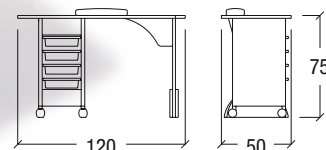

Kg 27

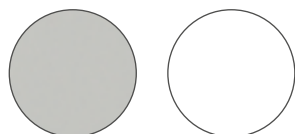

silver

bianco

Nobilitato. Pre-laminated.  
Laminé. Prelaminado.

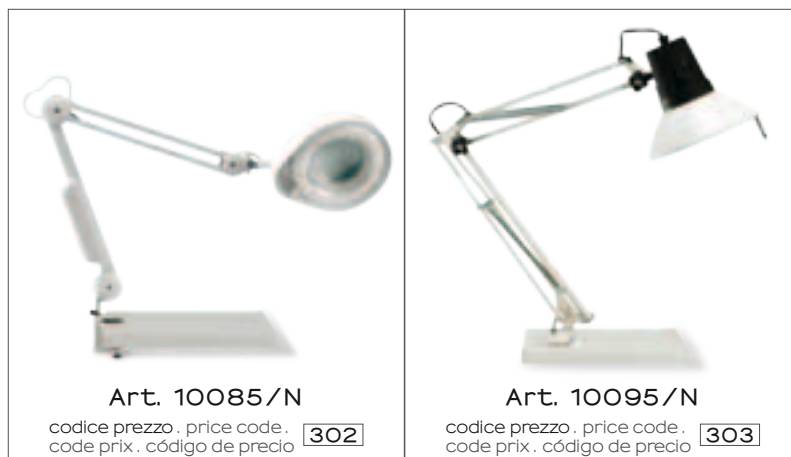

### Art. 10085/N

codice prezzo . price code . **302**  
code prix . código de precio

### Art. 10095/N

codice prezzo . price code . **303**  
code prix . código de precio

# Joey

## Art. 10075/N

codice prezzo . price code .  
code prix . código de precio **300**

Tavolo manicure in  
nobilitato nei  
2 colori indicati.

Manicure table in  
prelaminated in the  
2 indicated colours.

Table de manicure en  
laminé dans les  
2 couleurs indiquées.

Mesa de manicure en  
prelaminado en los  
2 colores indicados.

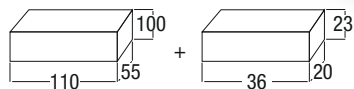
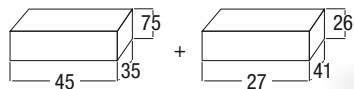
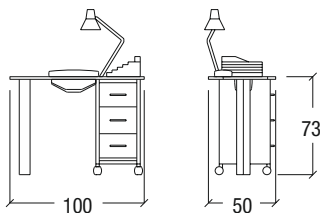

Kg 32

Cuscino poggiamani.  
Coussin appui main.  
Handrest cushion.  
Apoja mano.

### Art. 10082/N

codice prezzo . price code .  
code prix . código de precio **305**

Porta smalti.  
Nail polish holder.  
Porte produits.  
Porta productos.

### Art. 10081/N

codice prezzo . price code .  
code prix . código de precio **319**

Aspiratore.  
Nail dust collector.  
Aspirateur.  
Aspirador.

### Art. 10083/N

codice prezzo . price code .  
code prix . código de precio **301**



### Art. 10085/N

codice prezzo . price code .  
code prix . código de precio **302**



### Art. 10095/N

codice prezzo . price code .  
code prix . código de precio **303**



silver

bianco

Nobilitato. Pre-laminated.  
Laminé. Prelaminado.

# Alice

Art. 10085/N

**302** codice prezzo . price code .  
code prix . código de precio

Lampada tavolo con  
lente a 3 diottrie.

Magnifying lamp  
3 or 5 diopter.

Lampe pour table  
à 3 ou 5 dioptries.

Lampara por mesa  
à 3 o 5 dioptrías.

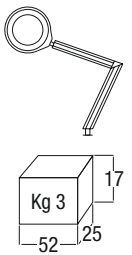

Art. 10086/N



Con piede  
With foot  
Avec pied  
Con pies

codice prezzo . price code . **304**  
code prix . código de precio

# Nelly

Art. 10095/N

**303** codice prezzo . price code .  
code prix . código de precio

Lampada a luce calda da tavolo.  
Lampadina eslusa.

Potenza massima 60 watt.

Warm light table lamp. Bulb not  
included. Max power: 60 watt.

Lampe chauffante pour table.  
Sans ampoule.

Puissance max: 60 watt.

Lampara luz caliente. Bombilla no  
incluida. Potencia max: 60 watt.

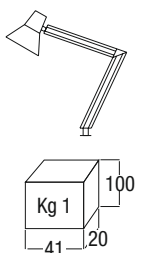

# Iggy

Art. 10090/N

codice prezzo . price code .  
code prix . código de precio **306**

Carrello manicure con  
piano appoggio.

Manicure trolley.

Manicure service.

Manicure carrito.

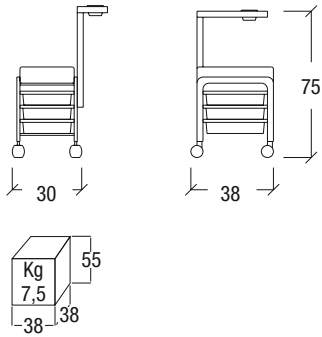

# Cindy

Art. 10100/N

**307** codice prezzo . price code .  
code prix . código de precio



Poltrona pedicure,  
con pompa a gas,  
in skai bianco.

Pedicure chair,  
with gas pump,  
in white skai.

Fauteuil de pedicure,  
avec pompe à gas,  
en skai blanc.

Sillon de pedicure,  
con bomba a gas,  
en skai blanco.

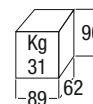
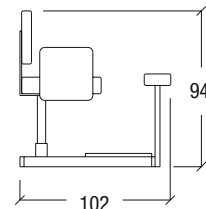
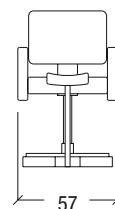

Con pompa idraulica.  
With hydraulic pump.  
Avec pompe hydraulique.  
Con bomba hydraulica.

**308** codice prezzo . price code .  
code prix . código de precio



# Sakura

## Art. 10050/B

codice prezzo . price code .  
code prix . código de precio **309**

Poltrona viso a schienale  
reclinabile, poggiatesta  
regolabile, tappezzeria  
in skai bianco.

Make-up chair with inclining  
back, adjusting embroidered  
head-rest, upholstery in  
white skai.

Make-up fauteuil avec  
dossier baissant,  
appui-tête réglable,  
tapissérie en skai blanc.

Make-up sillón con respaldo  
reclinable, apoja-cabeza  
regulable, tapicería de  
skai blanc.

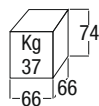
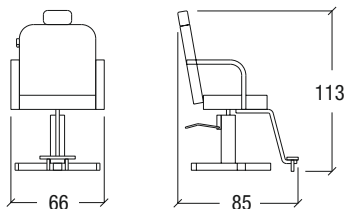

## Art. 10060/B

**310** codice prezzo . price code .  
code prix . código de precio

Vaporizzatore  
digitale viso.

Vaporizer digital  
for face.

Vaporisateur  
digitale pour visage.

Vaporizador digital  
por la cara.

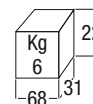
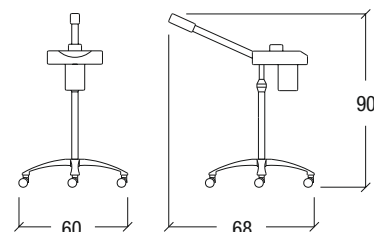

# Nikita

## Art. 10045/B

codice prezzo . price code .  
code prix . código de precio **311**

Poltrona trasformabile  
in lettino. Schienale  
super imbottito con  
foro e tappo. struttura  
in metallo verniciato,  
tappezzeria in skai  
bianco.

Chair transformable in  
bed. Back with a super  
padding with hole and  
plug. Frame in painted  
metal, upholstery in  
white skai.

Fauteuil transformable  
en lit. Dossier avec en  
super rembourrage  
avec trou et bouchon.  
Structure en metal  
verni, tapisserie en skai  
blanc.

Sillón transformable  
en cama. Respaldo con  
super mullido con hojo  
y tápon. Estructura en  
metal pintado, tapiceria  
en skai blanco.

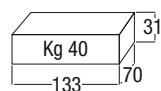
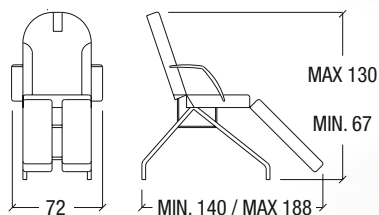



## Art. 10040/B

**312** codice prezzo . price code .  
code prix . código de precio

Poltrona trasformabile  
in lettino. Schienale  
super imbottito  
con foro e tappo.  
Struttura in metallo  
verniciato, tappezzeria  
in skai bianco.

Chair transformable in  
bed. Back with a super  
padding with hole and  
plug. Frame in painted  
metal, upholstery in  
white skai.

Fauteuil transformable  
en lit. Dossier avec en  
super rembourrage  
avec trou et bouchon.  
Structure en metal  
verni, tapisserie en skai  
blanc.

Sillón transformable  
en cama. Respaldo con  
super mullido con hojo  
y tápon. Estructura  
en metal pintado,  
tapiceria en skai  
blanco.

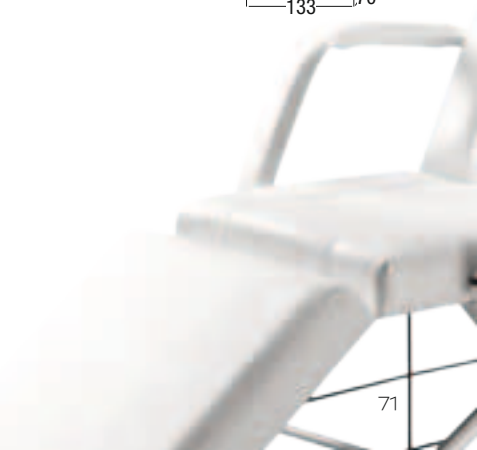
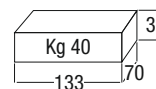
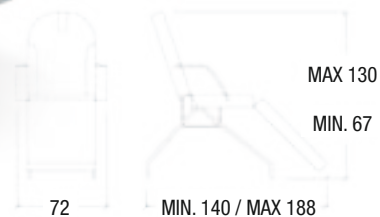

# Kallisto

## Art. 10020/B

codice prezzo . price code .  
code prix . código de precio **313**

Lettino massaggi a doppio movimento con porta rotolo. Struttura in metallo verniciato, tappezzeria in skai bianco.

Bed for massage with 2 mouvements with roll-holder. Frame in painted metal, upholstery in white skai.

Lit pour massage avec 2 mouvements avec porte-rouleau. Structure en metal verni, tapisserie en skai blanc.

Cama por masaje con 2 movimientos con porta-rollo. Estructura en metal pintado, tapiceria en skai blanco.

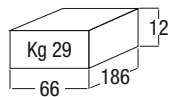
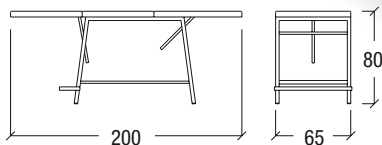

Art. 10030/B

314 codice prezzo . price code .  
code prix . código de precio



Lettino ad 1  
movimento con  
porta rotolo.  
Struttura in  
metallo verniciato,  
tappezzeria in skai  
bianco.

Bed with 1  
mouvement with  
roll-holder.  
Frame in painted  
metal, upholstery  
in white skai.

Lit avec 1  
mouvement avec  
porte-rouleau.  
Structure en  
metal verni,  
tapisserie  
en skai blanc.

Cama con 1  
movimiento con  
porta-rollo.  
Estructura en  
metal pintado,  
tapiceria  
en skai blanco.

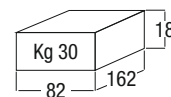
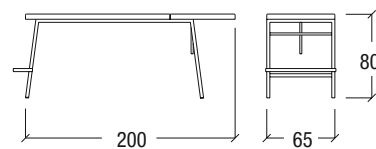

# Karma

Art. 10000/B

codice prezzo . price code .  
code prix . código de precio **315**

Lettino per fisioterapia  
a tre movimenti in legno  
multistrato verniciato  
naturale. imbottitura  
in gommapiuma con  
rivestimento in skai bianco  
con foro e tappo. Ripiano e  
portarotolo di serie.

Bed for physiotherapy with  
3 movements. Frame in  
painted natural wood.  
Foam rubber padding with  
cover white skai with hole  
and plug. Shelf and  
roll-holder in series.

Lit pour physiothérapie  
avec 3 mouvements,  
structure en bois verni  
naturel. Rembourrage  
en caoutchouc avec  
revêtement en skai blanc  
avec trou et bouchon.  
Rayon et porte-rouleau  
de série.

Cama por fisioterapia  
con 3 movimientos.  
Estructura de madera  
pintada natural. Mullido  
de gomaespuma con funda  
en skai blanco con hoyo y  
tápon. Estante y  
porta - rolo de serie.

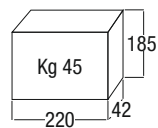
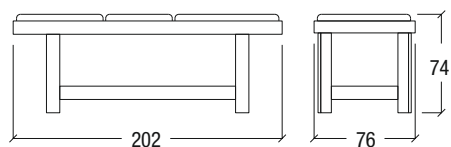

# Dioniso

Art. 10010/B

316 codice prezzo . price code .  
code prix . código de precio



Letto per fisioterapia ad un movimento in legno multistrato verniciato lucidato. Imbottitura in gommapiuma con rivestimento in skai bianco con foro e tappo. Ripiano e porta rotolo di serie.

Bed for physiotherapy with 1 movement. Frame in painted brilliant wood. foam rubber padding with cover white skai with hole and plug. Shelf and roll-holder in series.

Lit pour physiothérapie avec 1 mouvement. Structure en bois verni brillant. rembourrage en caoutchouc avec revêtement en skai blanc avec trou et bouchon. Rayon et porte-rouleau de série.

Cama por fisioterapia con 1 movimiento. Estructura de madera pintada brillante. Mullido de gomaespuma con funda en skai blanco con hoyo y tápon. Estante y porta-rollo de serie.

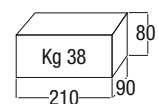
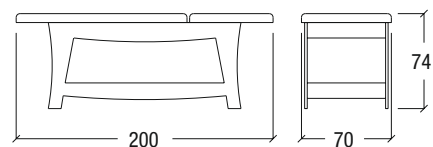

## Normal Skai

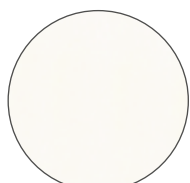

08



20

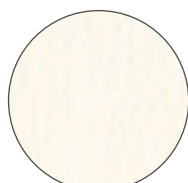

05

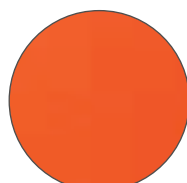

51

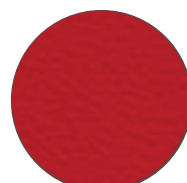

30

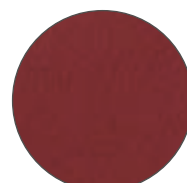

50

## Special Skai



B800



470



S84

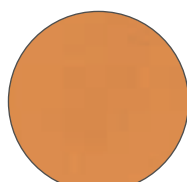

101

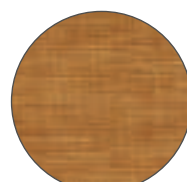

S05

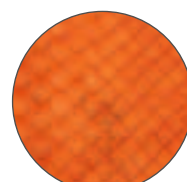

107



480



271



S03



S92

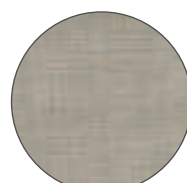

S06

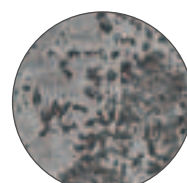

272

## Top Skai

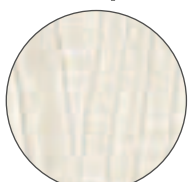

S31



S41

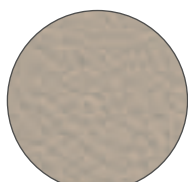

G502



G501

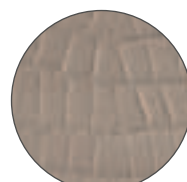

G505

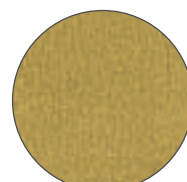

S011



S43



S24



S28



G516



G513



G512

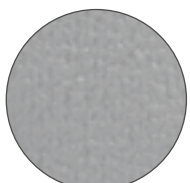

G503



G511



G510

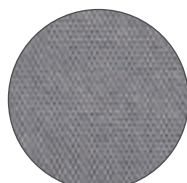

G515

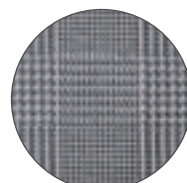

G514

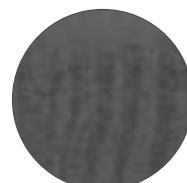

S44



34



09

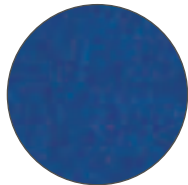

62

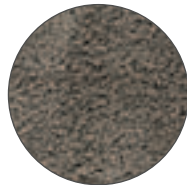

60



35



65

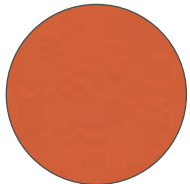

102

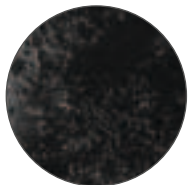

273



112

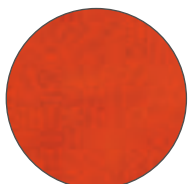

350

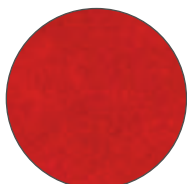

370



390

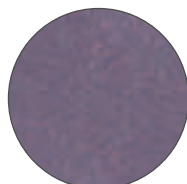

G507

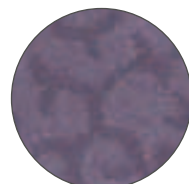

G506



430

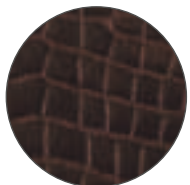

G504

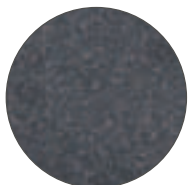

G509



G508



S25



400



G517

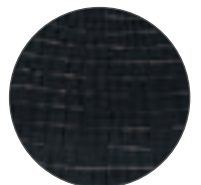

Nero 500



# schemi idraulici

water-system diagrams . schémas hydrauliques . esquemas hidráulicos

## Sid Art. 8050

Ingombro totale.  
Total encumbrance.  
Encombrement total.  
Medidas totales.

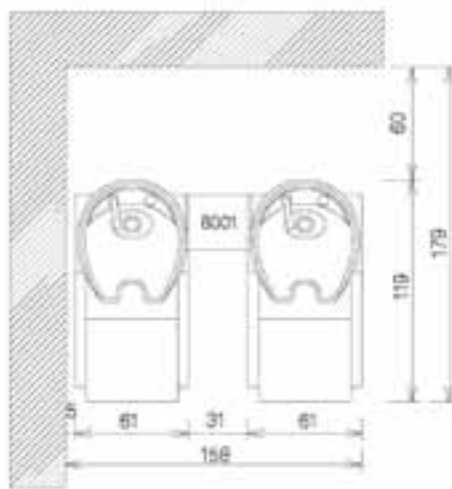
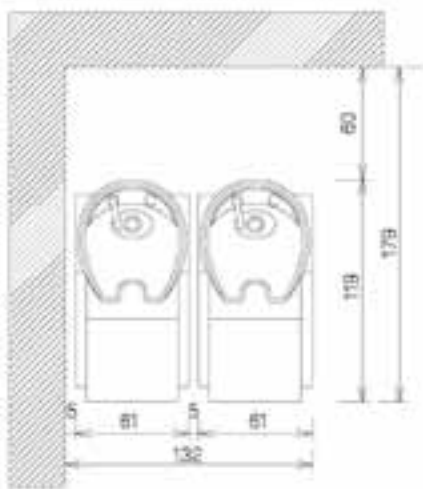

Posizione del centro scarico.  
Sistuation of the draining center.  
Position du centre de l'écoulement.  
Posición del centro de la descarga.

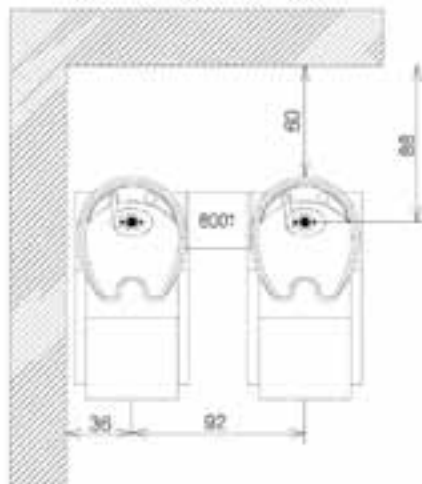
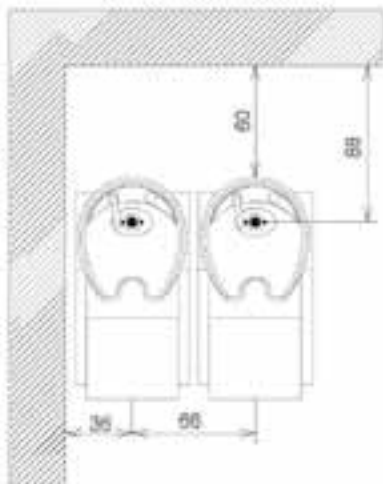

Spazio utile.  
Work space.  
Espace utile.  
Espacio útil.

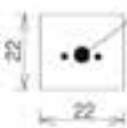

Scarico 50 mm.  
Draining 50 mm.  
Ecoulement 50 mm.  
Descarga 50 mm.

Scarico a muro.  
Draining at the wall.  
Ecoulement au mur.  
Descarga de muro.

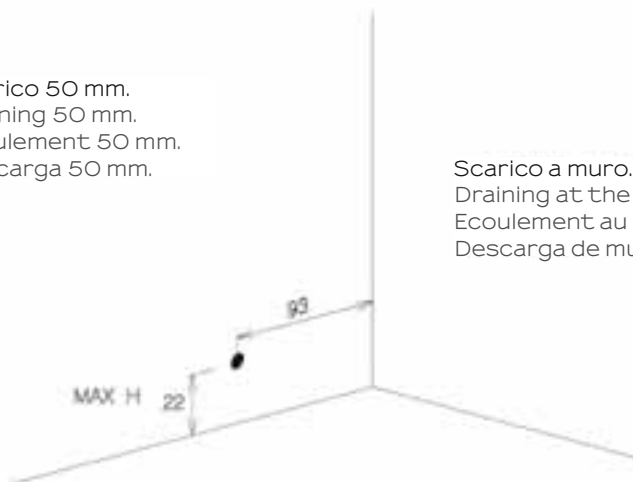



# Blur Art. 8030 / Anouk Wash Art. 8009 Spongy Art. 8015 / Jam Art. 8013

Ingombro totale.  
Total encumbrance.  
Encombrement total.  
Medidas totales.

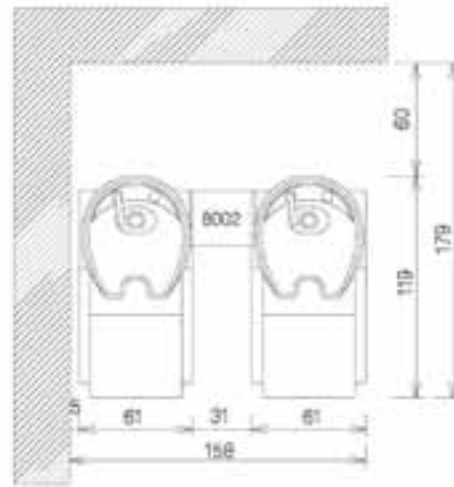
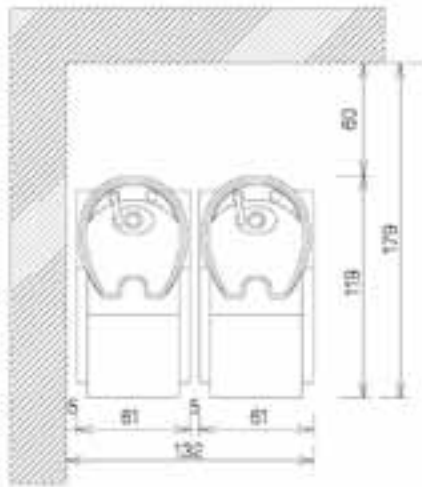

Posizione del centro scarico.  
Sistuation of the draining center.  
Position du centre de l'écoulement.  
Posición del centro de la descarga.

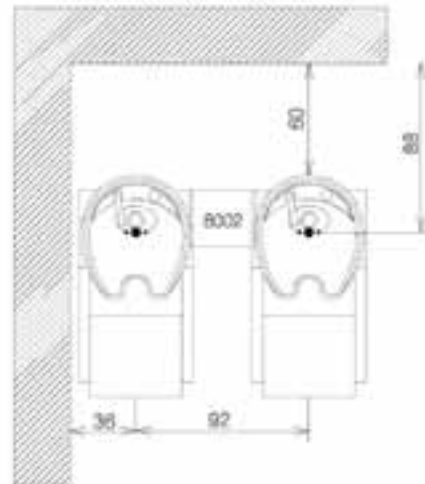
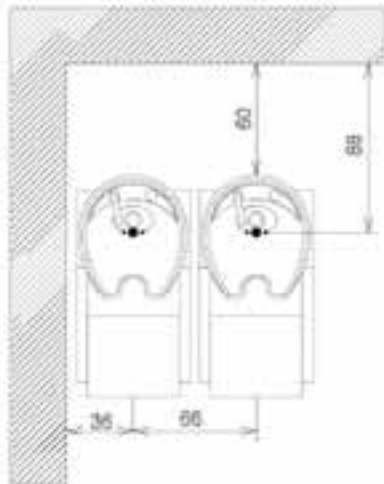

Spazio utile.  
Work space.  
Espace utile.  
Espacio útil.

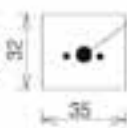

Scarico 50 mm.  
Draining 50 mm.  
Ecoulement 50 mm.  
Descarga 50 mm.

Scarico a muro.  
Draining at the wall.  
Ecoulement au mur.  
Descarga de muro.

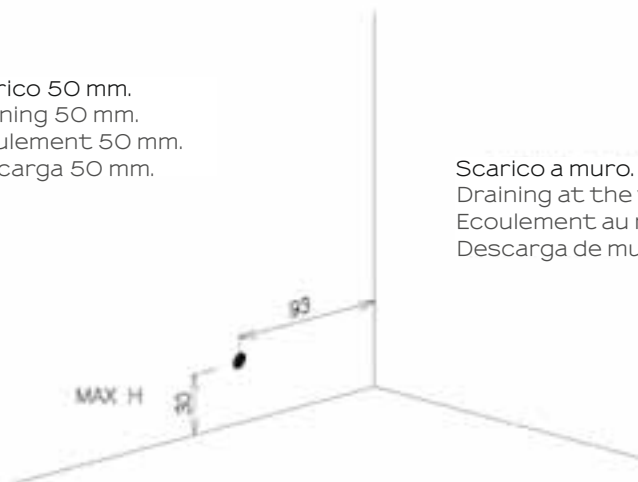

# schemi idraulici

water-system diagrams . schémas hydrauliques . esquemas hidráulicos

## Coconut Wash Art. 8021 Meg Wash Art. 8022

Ingombro totale.  
Total encumbrance.  
Encombrement total.  
Medidas totales.

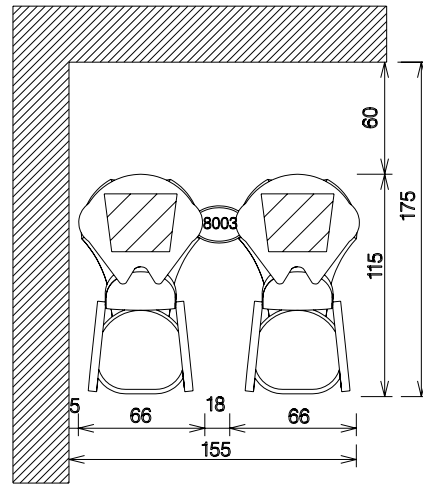
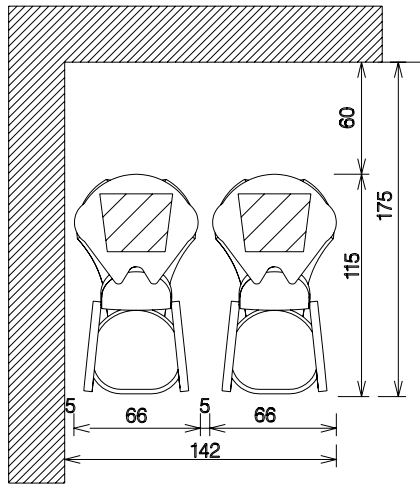

Posizione del centro scarico.  
Sistuation of the draining center.  
Position du centre de l'écoulement.  
Posición del centro de la descarga.

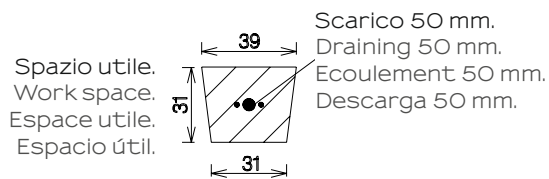
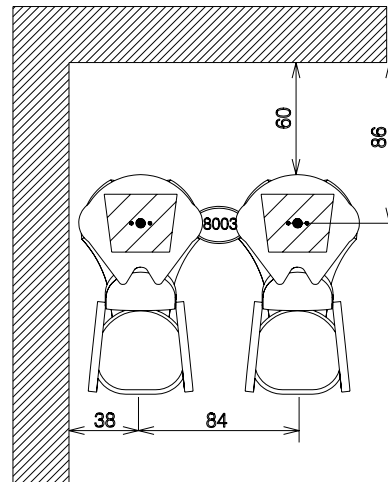
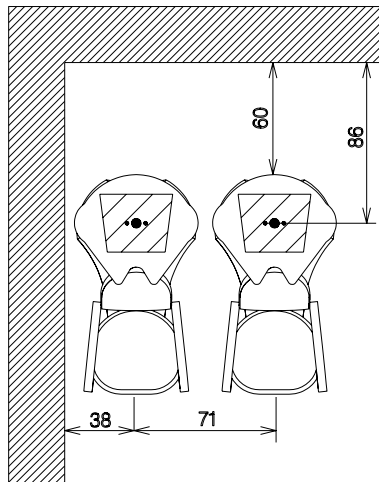

Scarico a muro.  
Draining at the wall.  
Ecoulement au mur.  
Descarga de muro.

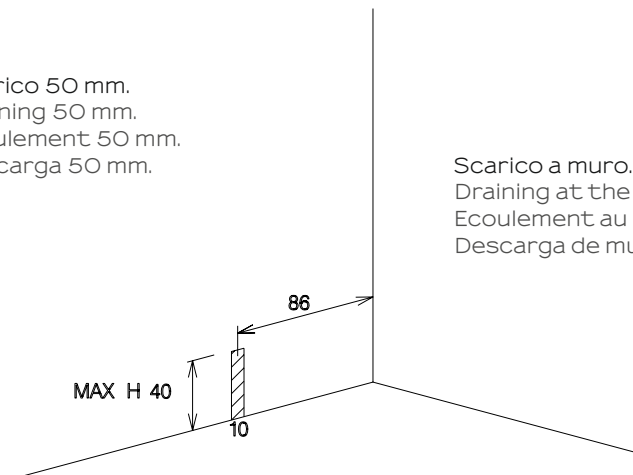

# Cube Wash Art. 8000

# Glam Wash Art. 8005

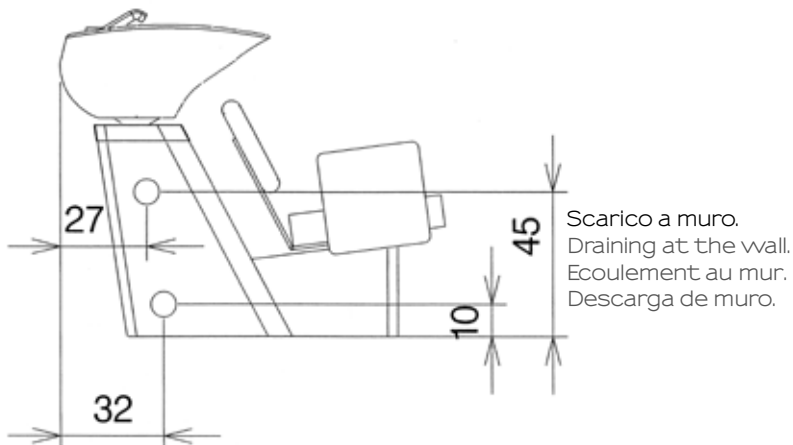
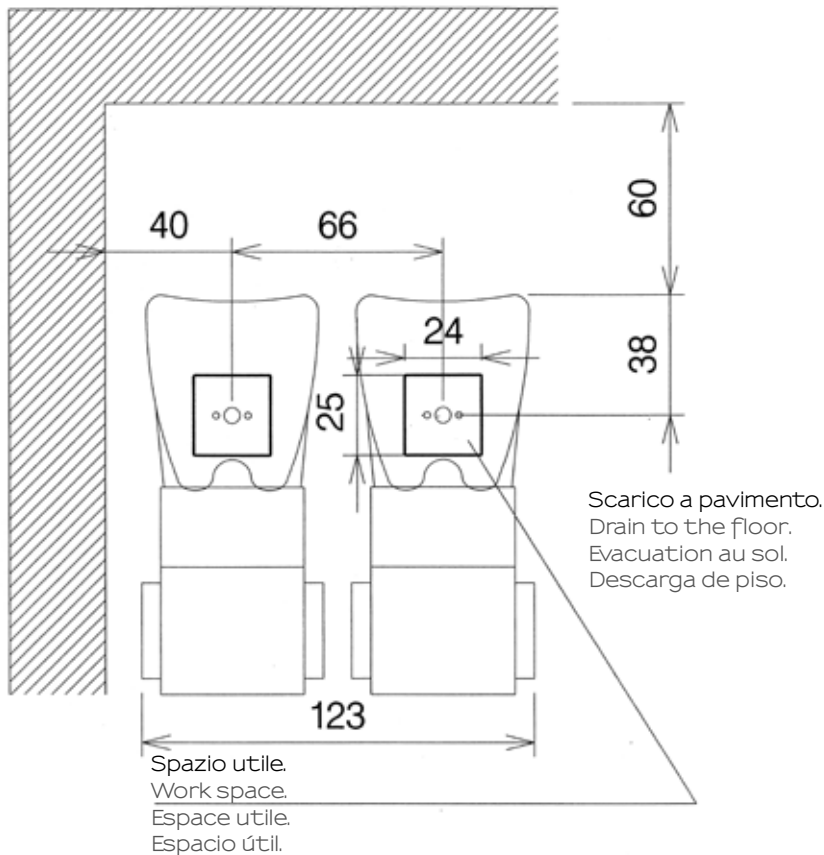

Le informazioni contenute nel seguente catalogo sono il più possibile esatte, ma non sono da ritenersi legalmente vincolanti.

I colori indicati si avvicinano quanto più possibile a quelli reali nei limiti consentiti dai processi di stampa.

The informations in this catalogue are as much as possible correct but they are not legal binding.

The colours are reproduced faithfully as much as printing processes so permit.

Les informations dans ce catalogue sont le plus possible correctes mais elles ne v pas légalement engageantes.

Les couleurs sont reproduits le plus proche de la réalité dans les limites du procès d'imprimerie.

Las informaciones en este catalogo son por el maximo posible correctas pero no son legalmente engageantes.

Los colores son por el maximo posible verdaderas en los limites del pleito de imprenta.

Coordinamento: MKTG. VEZZOSI

Progetto grafico: EUREKA!

Stampa: Ruggeri Grafiche

**VEZZOSI**EMPORIO



**SAVINGS & STYLE**

**VEZZOSI srl**

Via Martiri della Romania, 9  
42020 BORZANO - ALBINEA (RE) Italy

tel +39 0522 591721

fax +39 0522 591298

[info@vezzosiarredamenti.com](mailto:info@vezzosiarredamenti.com)

[www.vezzosiarredamenti.com](http://www.vezzosiarredamenti.com)

**VEZZOSI**EMPORIO

