



*Chic*collection

 **VEZZOSI**



# chic collection

## CHIC

Ricercatezza, stile e alta qualità: Chic Collection presenta l'haute-couture Vezzosi per la stagione 2010/2011. Pezzi unici, prestigiosi ma anche pret a portè! Per rinnovare il vostro ambiente senza troppi pensieri.

Refinement, style and high quality: Chic collection presents the haute-couture Vezzosi for the season 2010/2011. Unique pieces to renew your salon in an easy and care-free way

Préciosité, syle et haute qualité: Chic collection presente la haute-couture Vezzosi pour la saison 2010/2011. Pièces uniques et prestigieux pour renouveler votre salon sans-souci

Rebuscamiento, Estilo y calidad: Chic collection presenta la haute-couture Vezzosi 2010/2011. Productos unicos y preciosos para renovar tu salon Despreocupado

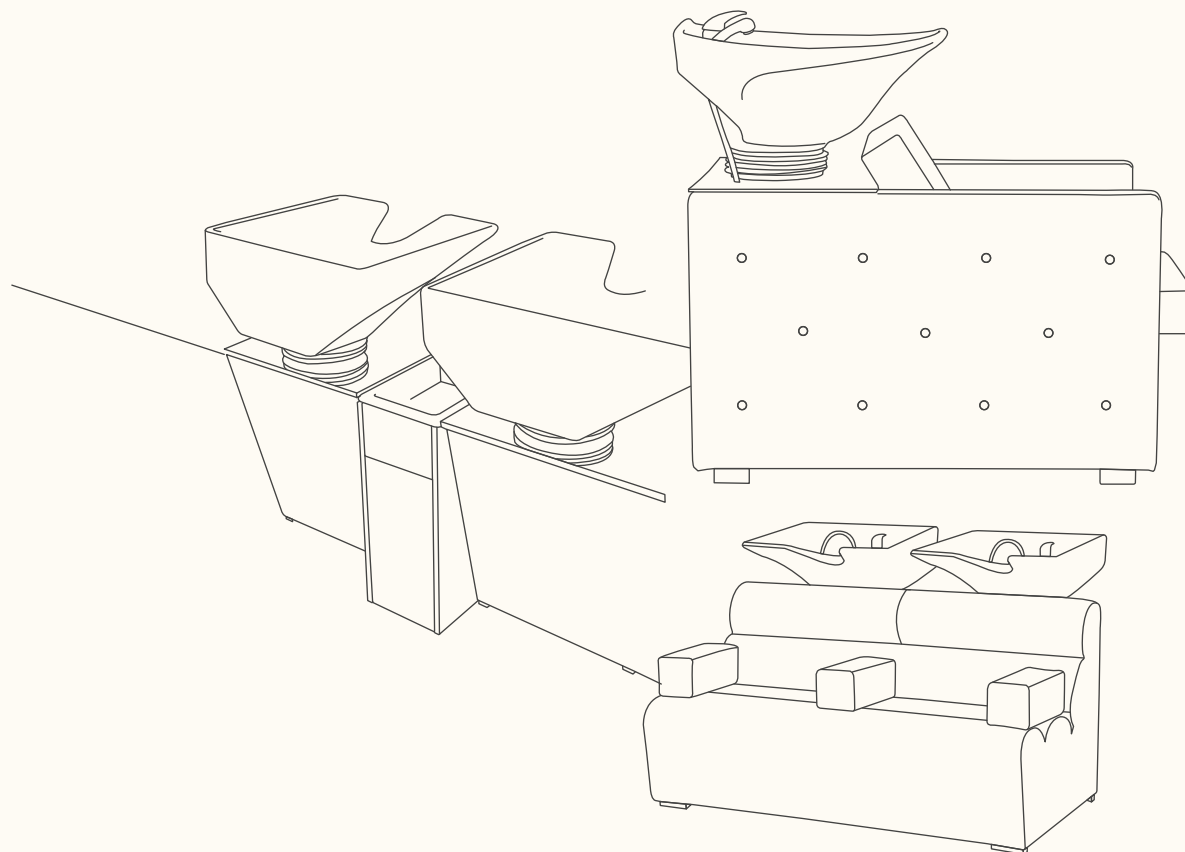

 **VEZZOSI**



Art. 3130





# *Napoleone*

Art. 3130

Lavaggio sofa 2 posti, lavello bianco basculante, flessibile antigoccia.

---

Washunit 2 places, white tilting basin, anti drop system.

---

Bac 2 places, cuvette basculante blanche, flexible anti ecoulement.

---

Lavacabeza doble, lavabo blanco basculante, flexible anti drop.



Art. 3135



# *Napoleone III*

Art. 3135

Lavaggio sofa  
3 posti, lavello  
bianco basculante,  
flessibile antigoccia.

---

Washunit 3 places,  
white tilting basin, anti  
drop system.

---

Bac 3 places, cuvette  
basculante blanche,  
flexible anti ecoulement.

---

Lavacabeza triple, lavabo  
blanco basculante, flexible  
anti drop.









## Re Sale

Art. 3140

Lavaggio sofa 2 posti, lavello bianco basculante, flessibile antigoccia.

---

Washunit 2 places, white tilting basin, anti drop system.

---

Bac 2 places, cuvette basculante blanche, flexible anti ecoulement.

---

Lavacabeza doble, lavabo blanco basculante, flexible anti drop.



Art. 3170



Art. 3575

Pannello copritubi  
Panel for covering the pipes  
Panneau cache tujaux  
Panel para cubrir los tubos



# Xilema Wash

Art. 3170

Struttura imbottita ricoperta in skai, braccioli acciaio inox, lavello bianco basculante, flessibile antigoccia.

Frame gilded and covered with skai. Tilting white basin. Armrest with protection in inox steel. Anti drop system.

Structure rembourrée et recouverte en skai, cuvette basculante blanche, protection accoudoirs en acier inox. Flexible anti écoulement.

Estructura embutida y recubierta en skai, lavabo blanco basculante, flexible anti drop.





Massaggio totale linfodrenante tonificante con flusso d'aria a variazione continua.  
Full lymphdraining invigorating massage by air flux at uninterrupted change.  
Massage total lymphodrainant tonifiant par flux d'air á variation continue.  
Masaje total linfodrenante y tónico a flujo de aire a variación continua.



Art. 3175

Art. 3575

Pannello copritubi  
Panel for covering the pipes  
Panneau cache tujaux  
Panel para cubrir los tubos



# Xilema airwash

Art. 3175

Struttura imbottita ricoperta in skai, braccioli acciaio inox, lavello bianco basculante, flessibile antigoccia. poggiatesta regolabile elettricamente. massaggio totale linfodrenante e tonificante a flusso d'aria continua.

Frame gilded and covered with skai. Tilting white basin. Armrest with protection in inox steel. Anti drop system. Adjusting legrest by electronics, full lymph-draining and invigorating massage by air flux at uninterrupted change.

Structure rembourrée et recouverte en skai, cuvette basculante blanche, protection accoudoirs en acier inox. Flexible anti écoulement. Appui-jambes réglable par l'électronique, massage total lymphé-drainant et tonifiant par flux d'air à variation continue.

Estructura embutida y recubierta en skai, lavabo blanco basculante, flexible anti drop. Apoya pies regulable para electronica, masaje total linfodrenante y tonico a flujo d'aire a variacion continua.

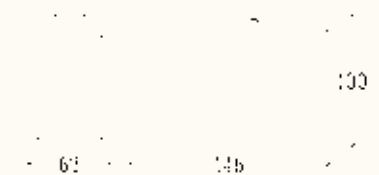



Art. 3190

**Art. 3575**

Pannello copritubi  
Panel for covering the pipes  
Panneau cache tuyaux  
Panel para cubrir los tubos



# Kubik

Art. 3190

Struttura imbottita e ricoperta in skai con finitura capitonné.  
Lavello bianco basculante.

---

Frame quilted and covered with skai with finish in capitonné. Tilting white basin.

---

Structure rembourrée et recouverte en skai avec finition capitonné. Cuvette basculante blanche.

---

Estructura embutida y recubierta en skai capitonné. Cerámica blanca basculante.





Art. 3195



Art. 3570  
Utility



Art. 3575

Pannello copritubi  
Panel for covering the pipes  
Panneau cache tuyaux  
Panel para cubrir los tubos





# Kubik massage

Art. 3195

Struttura imbottita e ricoperta in skai con finitura capitonné. Lavello bianco basculante. Massaggio Shiatsu nello schienale.

Frame quilted and covered with skai with finish in capitonné. Tilting white basin. Shiatsu massage in the back.

Structure rembourrée et recouverte en skai avec finition capitonné. Cuvette basculante blanche. Massage shiatsu dans le dossier.

Estructura embutida y recubierta en skai capitonné. Cerámica blanca basculante. Masaje shiatsu en el respaldo.

Art. 3195

180 x 70 x 100 cm  
180 x 70 x 100 cm

180 x 70 x 100 cm

Art. 3570

180 x 70 x 100 cm  
180 x 70 x 100 cm



Massaggio totale linfodrenante tonificante con flusso d'aria a variazione continua.  
Full lymphdraining invigorating massage by air flux at uninterrupted change.  
Massage total lymphodrainant tonifiant par flux d'air á variation continue.  
Masaje total linfodrenante y tónico a flujo de aire a variación continua.



Art. 3010



Lavello a basculazione controllata a pedale.  
Tilting basin controlled by pedal.  
Cuvette a basculation controllee par pedal.  
Lavabo basculante por pedal.



Art. 3560  
Utility



# Skyline

Art. 3000

Struttura in materiale poliuretano color bianco, tappezzeria in skai.

Frame in polyurethane material colour white, skai upholstery.

Structure en matériel poliuréthane couleur blanc, tapisserie en skai.

Estructura de material poliuretano color blanco, tapicería de skai.

Art. 3000



Art. 3010



Art. 3560



# Gaga

Art. 1338

Struttura interamente ricoperta in skai.

Gaga è presentata con base quadrata con pompa P99, senza pompa P98.

Structure totally upholstered with skai. Gaga is presented with squared base and pump P99, without pump P98.

Structure entièrement revêtue en skai. Gaga est présentée avec base carrée et pompe P99, sans pompe P98.

Estructura completamente revestida de skai. Gaga se presenta con base cuadrada con bomba P99, sin bomba P98.

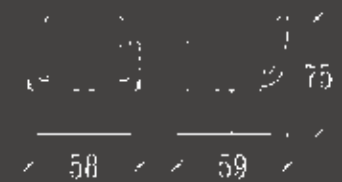

Art. 1338



Art. 1337



# Rubik

Art. 1337

Struttura interamente ricoperta in skai.

Rubik è presentata con base quadrata con pompa P99, senza pompa P98.

Structure totally upholstered with skai. Rubik is presented with squared base and pump P99, without pump P98.

Structure entièrement revêtue en skai. Rubik est présentée avec base carrée et pompe P99, sans pompe P98.

Estructura completamente revestida de skai. Rubik se presenta con base cuadrada con bomba P99, sin bomba P98.

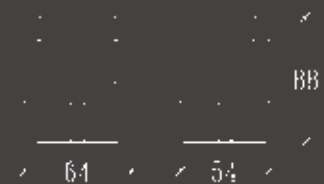



Art. 1327



# Devil

Art. 1327

Struttura interamente ricoperta in skai. Devil è rappresentata con base a disco in alluminio senza pompa P20 e P95. Devil può essere fornita con piede P70, P51 e nella versione P21 e P96 con pompa.

This structure is completely upholstered with skai fabrics. Devil is available with a round aluminium base without pump (P20 and P95). Devil is also available with P70, P51 foot and P21 and P96 version with pump.

Structure entièrement revêtue en skai. Devil se présente avec base à disque en aluminium sans pompe P20 et P95. Devil est disponible avec pied P70, P51 et en version P21 et P96 avec pompe.

Estructura completamente revestida de skai. Devil está realizada con base de disco de aluminio sin bomba P20 y P95. Devil se puede suministrar con pie P70, P51 y en la versión P21 y P96 con bomba.

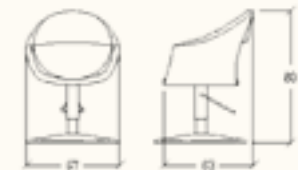



Art. 2970



Art. 2975





# White

Art. 2975

Fondale con struttura imbottita interamente ricoperta in skai e rifinita a capitonné.

---

Back guilted covered with skai, finish in capitonné.

---

Toile avec structure rembourrée recouverte en skai avec finition capitonné.

---

Respaldo embutido recubierto en skai capitonné.

Art. 2970

Panchetta con struttura imbottita interamente ricoperta in skai.

---

Seat guilted covered with skai.

---

Banquette avec structure rembourrée recouverte en skai.

---

Asiento embutido recubierto de skai.

Art. 2975

Art. 2970



Art. 6300

Art. 6305

Struttura in laminato plastico  
o in legno laccato con  
decoro in bassorilievo.

Frame in plastic laminated or in  
laquered wood with decoration in low  
relief.

Structure en stratifié ou en bois laqué  
avec decoration en bas relief.

Estructura en laminado o en madera  
laqueada con decoracion.

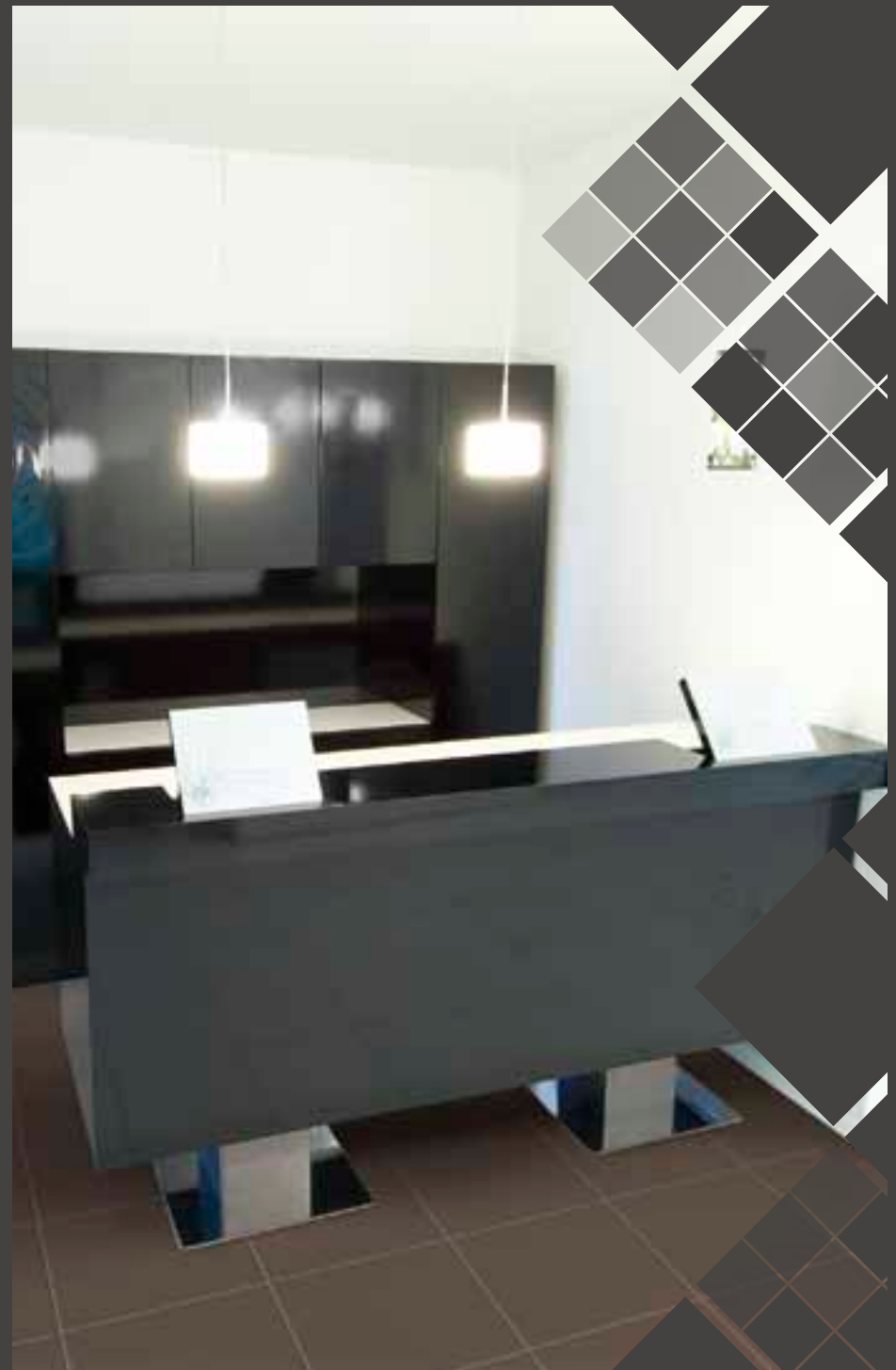

Art. 6305

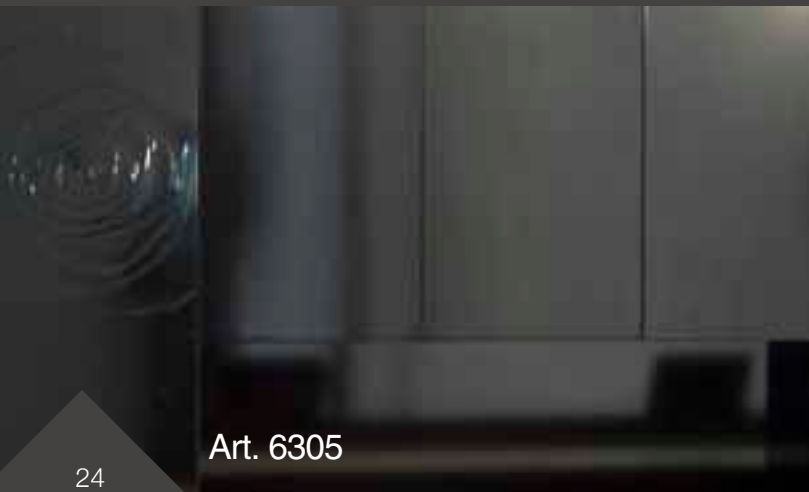

Art. 6305



## Colour Bar

Art. 6305

Struttura in laminato plastico o in legno laccato con decoro in bassorilievo, specchi basculanti, piedi in inox, top in laminato.

Frame in plastic laminated or in laquered wood with decoration in low relief, tilting mirrors, feet in shine inox, top in plastic laminated.

Structure en stratifié ou en bois laqué avec décoration en bas relief, miroirs escamotables, top en stratifié.

Estructura en laminado o en madera laqueada con decoración, espejos basculantes, pies en inox pulido, top en laminado.

Art. 6300





# Moon Collection

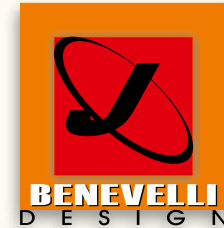

Moon rappresenta la sintesi di un ambiente che guarda al futuro con la leggerezza della fantasia e la concretezza della tecnologia.

Moon oltre lo spazio e il tempo!

---

Moon represents the synthesis of an ambiente that looks at the future with the lightness of the fantasy and the concreteness of the technology. Moon beyond the time and the space!

---

Moon represente la synthese d'une ambiente qui regarde vers le futur avec la légereté de l'imagination et la tangibilité de la technologie. Moon au-delà du temps et de l'espace!

---

Moon representa la sintesis de un ambiente que mira al futuro con la ligereza de la Fantasia y la Cualidad de concreto de la Tecnologia. Moon Adelante el tiempo y el espacio.



Art. 4003





# Moon Double

Art. 4003

Struttura metallo verniciato,  
piano lavoro in plexiglass  
satinato con inserto in skai.  
Illuminazione incorporata.

Frame in painted metal, top in plexiglass  
with incorporated file in skai.  
Decorative lighting.

Structure en metal verni, tablette en plexiglass  
avec supplément en skai.  
Illumination decorative.

Estructura de metal barnizado, encimera  
en plexiglass con decoracion de skai.  
Iluminacion decorativa.





Art. 4001

Struttura metallo verniciato, piano lavoro in plexiglass satinato con inserto in skai. Illuminazione incorporata. Specchio laterale a scomparsa.

Frame in painted metal, top in plexiglass with incorporated file in skai. Decorative lighting. Lateral mirror.

Structure en metal verni, tablette en plexiglass avec supplément en skai. Illumination decorative. Miroir lateral à disposition.

Estructura de metal barnizado, encimera en plexiglass con decoracion de skai. Iluminacion decorativa. Espejo lateral nido.

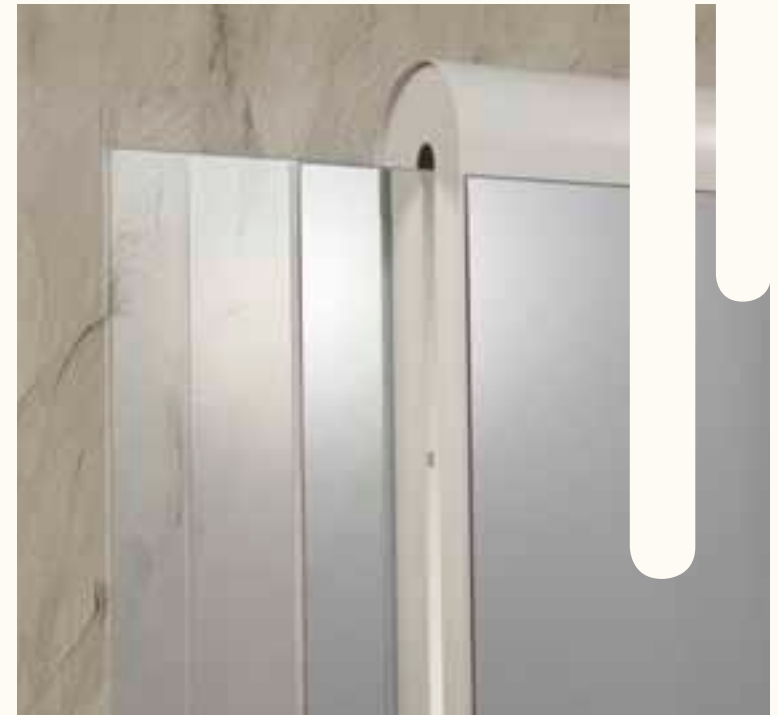





Art. 4000

# Moon Wall

Art. 4000

Struttura metallo verniciato, piano lavoro in plexiglass satinato con inserto in skai. Illuminazione incorporata.

Frame in painted metal, top in plexiglass with incorporated file in skai. Decorative lighting.

Structure en metal verni, tablette en plexiglass avec supplément en skai. Illumination decorative.

Estructura de metal barnizado, encimera en plexiglass con decoracion de skai. Iluminacion decorativa.





Art. 1335



# Moon Chair

Art. 1335

Base circolare in alluminio verniciato con pompa P10 senza pompa P11. Braccioli con inserti in plexiglass.

Base in painted aluminium with pump P10, without pump P11, armrest with plexiglass decoration

Base en aluminium verni avec pompe P10, sans pompe P11, accoudoirs avec decoration en plexiglass

Base de aluminio barnizado con bomba P10 sin bomba P11, brazos con decoracion de plexiglass

Art. 1336

Base circolare in alluminio verniciato con pompa P10 senza pompa P11.

Base in painted aluminium with pump P10, without pump P11.

Base en aluminium verni avec pompe P10, sans pompe P11.

Base de aluminio barnizado con bomba P10 sin bomba P11.



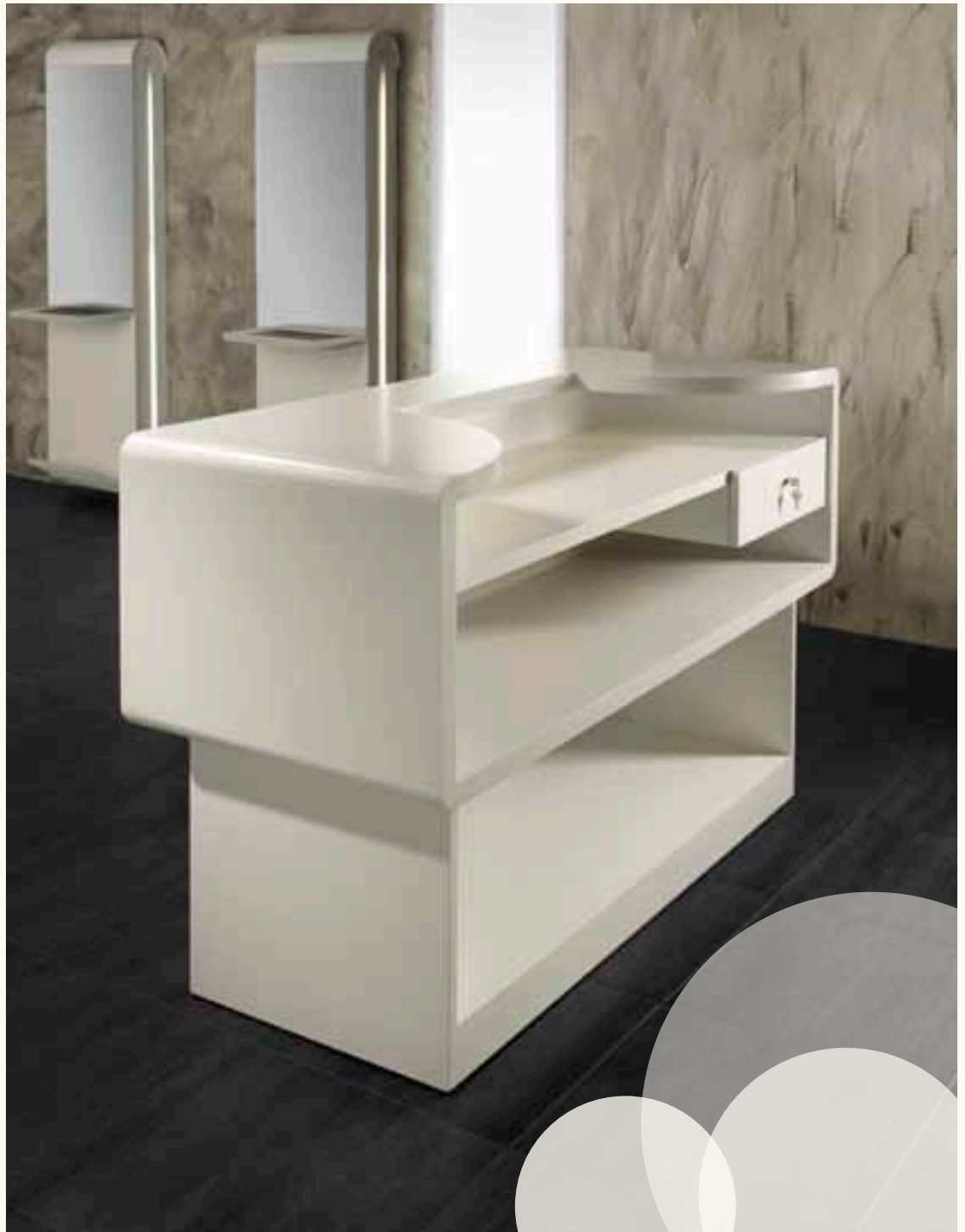



# *Moon Reception*

Art. 6000

Struttura laccata esternamente, in prelaminato bianco internamente. Frontale in skai illuminazione decorativa incorporata.

---

Frame in white laminated inside, laquered outside. Frontal in skai with lighting incorporated.

---

Structure laquée à l'extérieur en stratifié blanc à l'intérieur. Frontal en skai, illumination décorative incorporée.

---

Estructura lqueada a l'exterior en laminado blanco al interior. Frontal en skai, iluminacion incorporada.



**Art. 7296**

Portariviste  
Newspaper holder  
Porte revues  
Carrito por revistas

# Moon Pouff

Art. 2701

Base circolare in alluminio verniciato. Con schienale art 2701, senza schienale 2700.

Base in painted aluminium. With backrest art 2701, without backrest art 2700.

Base en aluminium verni. Avec dossier art 2701, sans dossier art 2700.

Base de aluminio barnizado. Con respaldo art 2701, sin respaldo art 2700.



Art. 2701

Art. 2700





Art.500







# Moon Expo

Art. 500

Base in alluminio verniciato,  
struttura in legno laccato,  
piani in vetro.

Base in painted aluminium, frame in  
laquered wood, glass shelves.

Base en aluminium verni, structure en bois  
laqué, étagères en verre.

Base de aluminio barnizado, estructura  
de madera laqueada, encimeras de  
cristal.

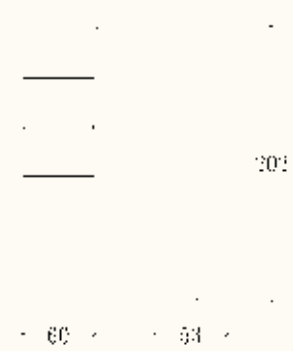

Una rivoluzione di concetto. Una linea perfetto connubio tra forma e funzione. e il designer Denis Santachiara ha arredare il salone: con le forme liquide in un autentico salotto e in un luogo di proposte che si aggiungono alla gamma carattere pOd per un ambiente unico,

A concept revolution. An innovative line with a refined design. A perfect mix of shape and functionality. The success of the relationship between Vezzosi and designer Denis Santachiara gave a new course to the way you can equip your salon: with the new, supple design of the pOd line salons become real lounges, a place for relaxation and entertainment. These new proposals add up to our product range and to the pOd line, for your salon to be exclusive, elegant and trendy.

Un concept révolutionnaire. Une ligne innovante au design recherché. Une alliance parfaite entre design et fonction. Le succès du rapport entre Vezzosi et le designer Denis Santachiara a donné un cours nouveau aux façons d'aménager les salons de coiffure: les formes fluides et sinueuses de pOd ont transformé les salons en un espace de relax et de loisirs. Les nouvelles propositions, qui enrichissent la gamme, s'alignent et suivent le caractère de pOd pour réaliser un salon unique, élégant et de tendance.

innovativa dal design ricercato. Il  
Il successo del rapporto tra Vezzosi  
impresso un nuovo corso al modo di  
e sinuose di pOd lo ha trasformato  
relax e intrattenimento. Le nuove  
si allineano e proseguono il  
elegante e di tendenza.

La revolución de un concepto. Una línea innovadora del diseño buscado. La combinación perfecta entre forma y función. El éxito de la relación entre Vezzosi y el diseñador Denis Santachiara ha dado una nueva impronta al modo de decorar el salón: con las formas líquidas y sinuosas de pOd lo ha transformado en una auténtica sala de estar, en un lugar de relax y entretenimiento. Las nuevas propuestas que se añaden a la gama se alinean y siguen el carácter pOd de un ambiente único, elegante y de tendencia.



by SANTACHIARA



art. 9004

Poggiagambe regolabile elettricamente con pulsantiera.

Adjusting legrest by electronics.

Appui-jambes réglable par l'électronique.

Apoya piernas regulable electricamente.



Art.9003



## AIR MASSAGE

IL NUOVO LAVAGGIO POD E' DOTATO DI MASSAGGIO AD ARIA. LA PIU' EFFICACE TECNOLOGIA DI MASSAGGIO APPLICATA AL LAVAGGIO PIU' COMODO ED ACCOGLIENTE, PER RENDERE LA PERMANENZA DEI CLIENTI UNA VERA E PROPRIA SEDUTA BENESSERE.

THE NEW WASHUNIT POD NOW WITH AIR MASSAGE, TOP TECHNOLOGY FOR THE BEST COMFORT.

LE NOUVEAU BAC POD AVEC MASSAGE A' AIR, LA MEILLEURE TECHNOLOGIE POUR LE COMFORT TOTAL.

EL NUEVO LAVACABEZA POD CON MASAJE A' AIRE, LA MEJOR TECNOLOGIA POR EL MAXIMO COMFORT.

art. 9003

Poggiagambe regolabile elettricamente. massaggio totale linfodrenante e tonificante a flusso d'aria continua.

Adjusting legrest by electronics, full lymph-draining and invigorating massage by air flux at uninterrupted change.

Appui-jambes réglable par l'électronique, massage total lymph-drainant et tonifiant par flux d'air a' varriation continue

Apoja pies regulable para electronica, masaje total linfodrenante y tonico a flujo d'aire a variacion continua.



## NUOVO LAVANDINO, MASSIMA CAPIENZA

PRATICO E FUNZIONALE PER  
AGEVOLARE IL TUO LAVORO

MORE SPACE AND LARGER  
DIMENSIONS TO MAKE YOUR WORK  
EASIER

PLUS D'ESPACE ET DIMENSIONS  
PLUS GRANDES POUR RENDRE TON  
TRAVAIL PLUS COMFORTABLE.

MAS ESPACIO Y DIMENSIONES  
MAS GRANDES PARA FACILITAR TU  
TRABAJO

## REGOLAZIONE DEL LAVANDINO:

CON IL NUOVO LAVAGGIO POD L'ACCESSO ALLA  
REGOLAZIONE DEL LAVANDINO BASCULANTE È PIU'  
COMODA ED IMMEDIATA.  
FACILE ACCESSO ALLA REGOLAZIONE DEL  
LAVANDINO BASCULANTE

WITH THE NEW WASHUNIT POD THE ACCES TO  
THE BASIN REGULATION IS MUCH EASIER AND  
IMMEDIATE

AVEC LE NOUVEAU BAC POD L'ACCES A' LA  
REGULATION DE LA CUVETTE EST PLUS FACILE ET  
IMMEDIATE

CON EL NUEVO LAVACABEZA POD LA REGULACION  
DE LA CERAMICA ES MUCHO MAS SIMPLE Y  
IMEDIATA

## MASSIMO COMFORT

IL POGGIAGAMBE È PIU' AMPIO PER  
GARANTIRE AI TUOI CLIENTI IL MASSIMO  
COMFORT

THE FOOT-REST IS LARGER TO GIVE THE  
BEST COMFORT

LE REPOSE PIEDS EST PLUS LARGE POUR  
DONNER ENCORE PLUS DE COMFORT

EL APOJA PIES EST MAS ANCHO PARA DAR  
UN MEJOR COMFORT



## SGABELLO MOBILE

IL LAVORO DEL PARRUCCHIERE È FATTO DI CREATIVITÀ E PASSIONE! LA VEZZOSI QUESTO LO SA, E SA ANCHE CHE PER MANTENERE VIVA LA PASSIONE È NECESSARIO RIDURRE LA FATICA. L'ULTIMA INNOVAZIONE DELL'UFFICIO ENGINEERING VEZZOSI È LO SGABELLO MOBILE PER IL LAVAGGIO. ERGONOMICO, CON POGGIPIEDI E REGOLABILE IN ALTEZZA VI PERMETTERÀ DI LAVORARE AL MEGLIO CONCEDENDO UN PO DI SOLLIEVO AL VOSTRO CORPO.

THE HAIRDRESSER JOB MEANS CREATIVITY AND PASSION AND VEZZOSI KNOWS IT. WE KNOW ALSO THAT IN ORDER TO GET THE PASSION ALIVE IT IS NECESSARY TO REDUCE THE FATIGUE.

THE LAST INVENTION OF VEZZOSI ENGINEERING OFFICE IS THE MOVING TROLLEY FOR THE WASHUNIT. ERGONOMIC, WITH FOOT-REST, ADJUSTING IN HEIGHT, IT WILL PERMIT YOU TO WORK BETTER AND MORE COMFORTABLE

LE TRAVAIL DU COIFFEUR EST CREATIVITE' ET PASSION ET VEZZOSI LE SAIT BIEN, IL SAIT AUSSI QUE POUR MANTENIR LA PASSION VIVE IL FAUT DIMINUER LA FATIGUE.

LA NOUVELLE INNOVATION DE L'ENGINEERING BUREAU VEZZOSI EST LE TABOURET POUR BAC.

ERGONOMIC, AVEC REPOSE-PIEDS ET REGLABLE EN HAUTEUR, CE TABOURET TE PERMETTRA DE TRAVAILLER MIEUX ET PLUS COMFORTABLE.

EL TRABAJO DE PELUQUERO ES CREATIVIDAD Y PASION Y VEZZOSI LO SABE BIEN. LOS INGENIEROS DE VEZZOSI HAN ESTUDIADO EL TABOURETE MOVIL POR LAVACABEZA. ERGONOMIC, CON APOJA-PIES Y REGULABLE EN ALTURA PARA TRABAJAR EN EL MAXIMO COMFORT

## REGOLAZIONE DEL LAVANDINO:

CON IL NUOVO LAVAGGIO POD L'ACCESSO ALLA REGOLAZIONE DEL LAVANDINO BASCULANTE È PIU' COMODA ED IMMEDIATA. FACILE ACCESSO ALLA REGOLAZIONE DEL LAVANDINO BASCULANTE

WITH THE NEW WASHUNIT POD THE ACCES TO THE BASIN REGULATION IS MUCH EASIER AND IMMEDIATE

AVEC LE NOUVEAU BAC POD L'ACCES A' LA REGULATION DE LA CUVETTE EST PLUS FACILE ET IMMEDIATE

CON EL NUEVO LAVACABEZA POD LA REGULACION DE LA CERAMICA ES MUCHO MAS SIMPLE Y IMEDIATA

art. 9837  
Sgabello Pod  
Pod stool  
Tabouret Pod  
Taburete Pod



# *New Skai*



Special 470



Top S31

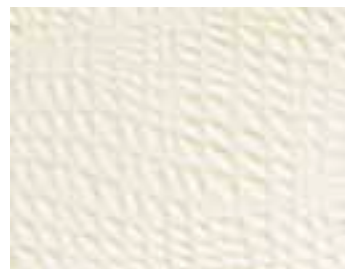

Top S84



Top S41



Special S06



Top S44

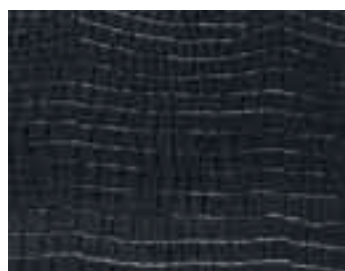

Top Cocco Nero 500



Top S25

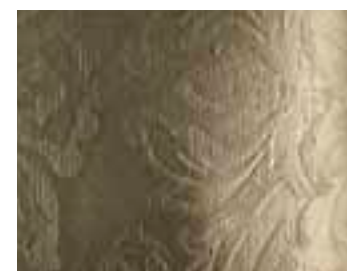

Top S24



Special 480



Top S43



Top S28



Special S05



Top S07



Top S011



Top S92

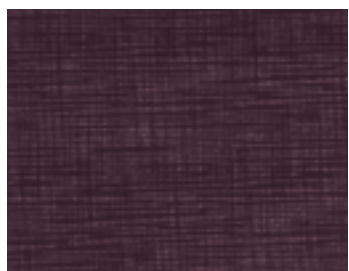

Special S03



# Schemi idraulici

ART.3195 KUBIK SHATSU E ART.3175 XILEMA AIR WASH

SCHEMA IDRAULICO

SCHEMA HYDRAULIQUE

HYDRAULIC PLAN

HYDRAULISCHE PLAN

INGOMBRO TOTALE  
ENCOMBREMENT TOTAL  
TOTAL ENCUMBRANCE

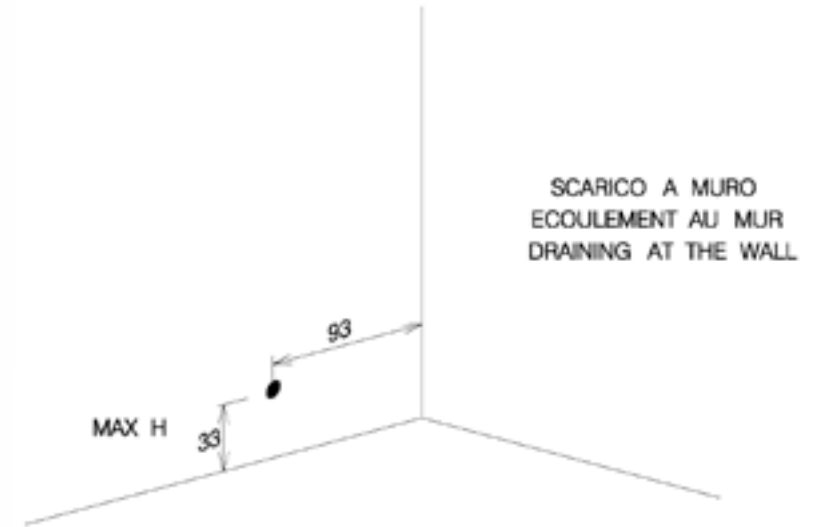
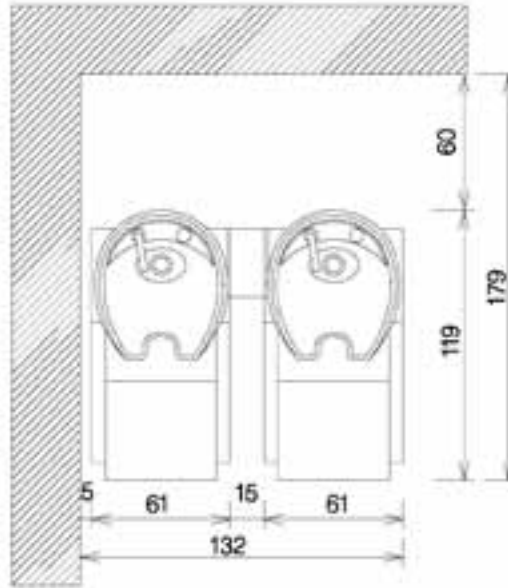
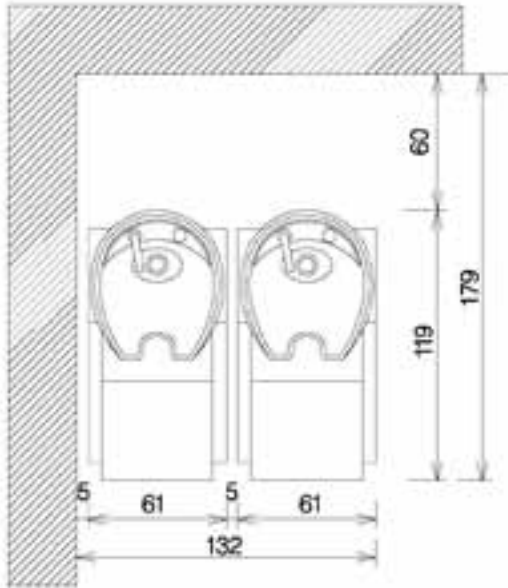

POSIZIONE DEL CENTRO SCARICO  
POSITION DU CENTRE DE L'ECOULEMENT  
SITUATION OF THE DRAINING CENTER

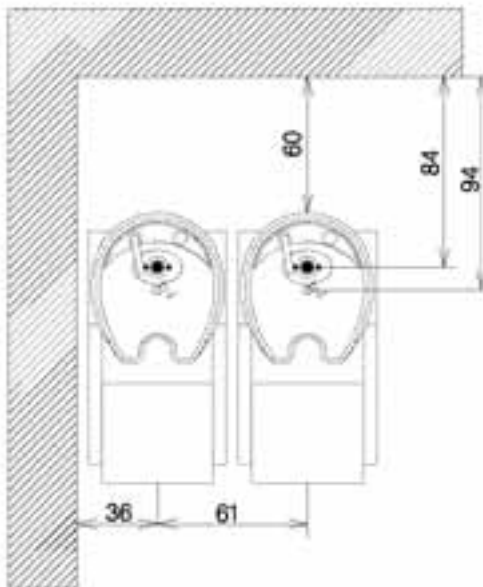

uscita del cavo elettrico da pavimento  
sortie du cable électrique du sol  
exit of the electric cable from the floor

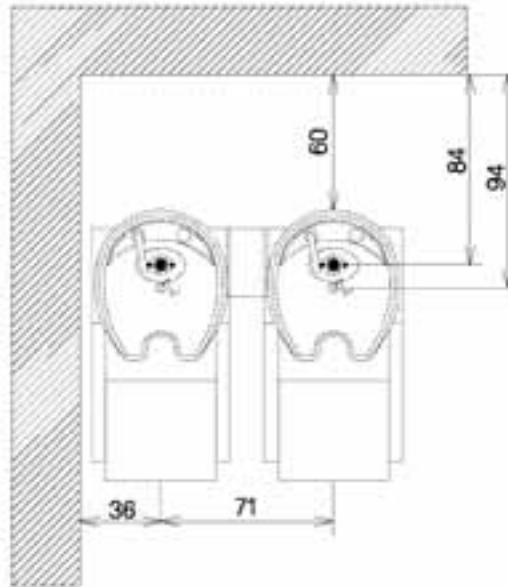

uscita del cavo elettrico da pavimento  
sortie du cable électrique du sol  
exit of the electric cable from the floor

SPAZIO UTILE  
ESPACE UTILE  
WORK SPACE

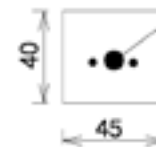

SCARICO MM 50  
ECOULEMENT MM50  
DRAINING MM50

# Schemi idraulici

ART.3140 RE SOLE ART.3130 NAPOLEONE ART.3135 NAPOLEONE III

SCHEMA IDRAULICO

SCHEMA HYDRAULIQUE

HYDRAULIC PLAN

HYDRAULISCHE PLAN

INGOMBRO TOTALE  
ENCOREMENT TOTAL  
TOTAL ENCUMBRANCE

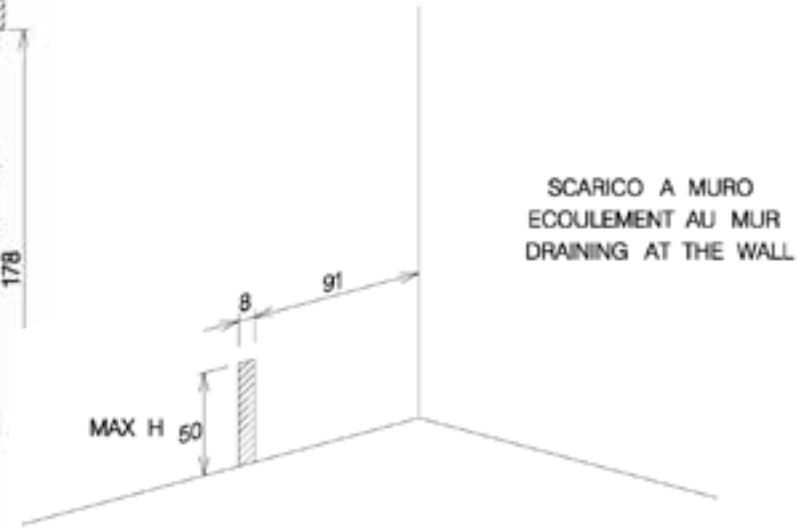
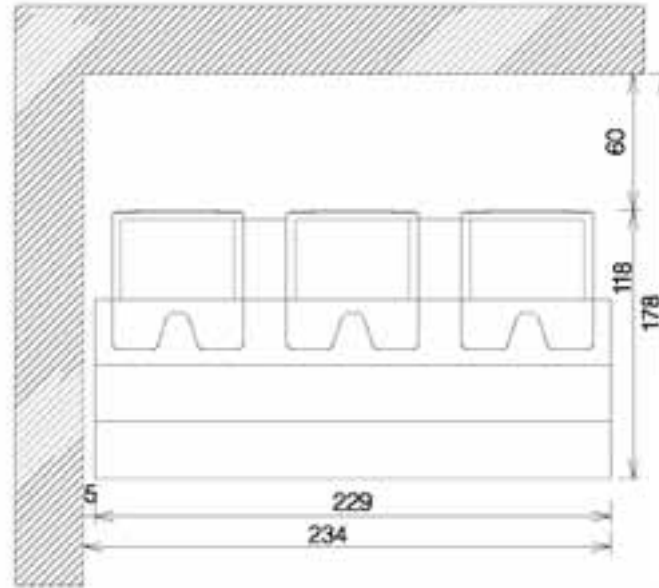
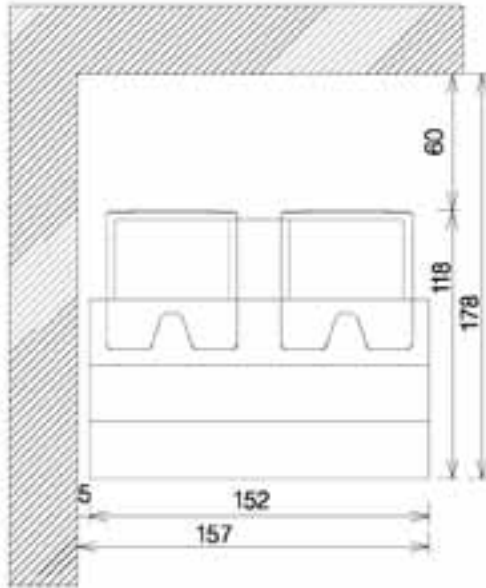

POSIZIONE DEL CENTRO SCARICO  
POSITION DU CENTRE DE L'ECOULEMENT  
SITUATION OF THE DRAINING CENTER

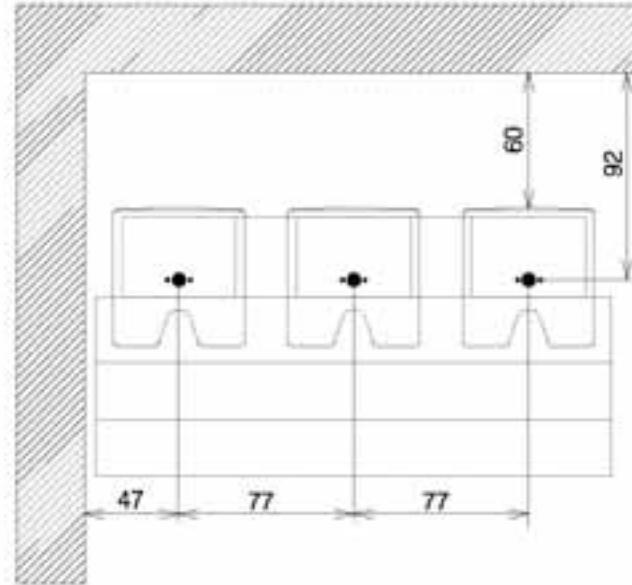
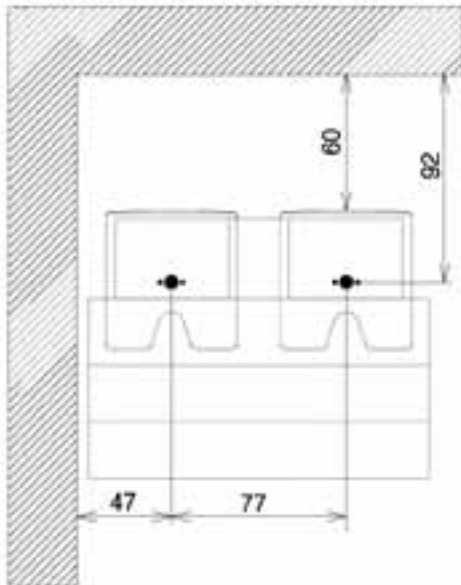

SPAZIO UTILE  
ESPACE UTILE  
WORK SPACE

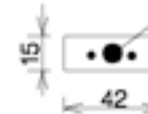

SCARICO MM 50  
ECOULEMENT MM50  
DRAINING MM50

# Schemi idraulici

ART. 3190 KUBIK		E	ART. 3170 XILEMA WASH	
SCHEMA IDRAULICO	SCHEMA HYDRAULIQUE		HYDRAULIC PLAN	HYDRAULISCHE PLAN

INGOMBRO TOTALE  
ENCOREMENT TOTAL  
TOTAL ENCUMBRANCE

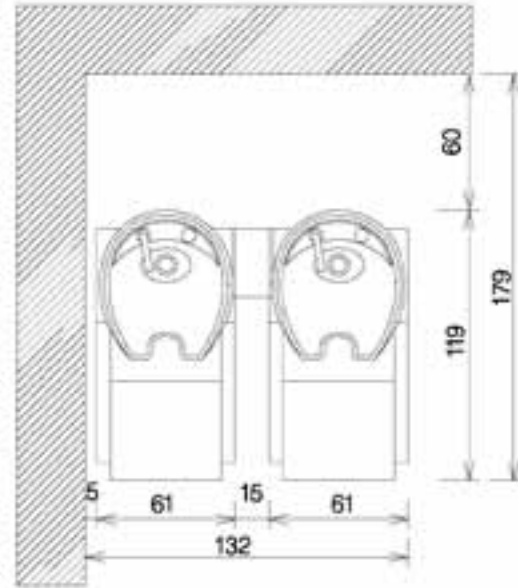
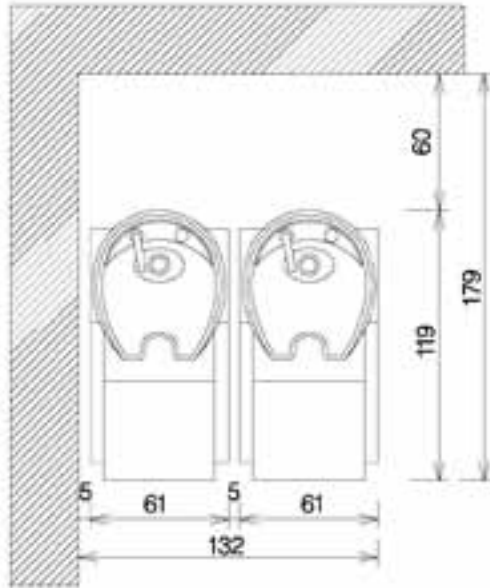

POSIZIONE DEL CENTRO SCARICO  
POSITION DU CENTRE DE L'ECOULEMENT  
SITUATION OF THE DRAINING CENTER

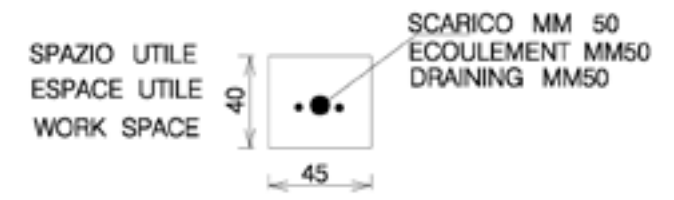
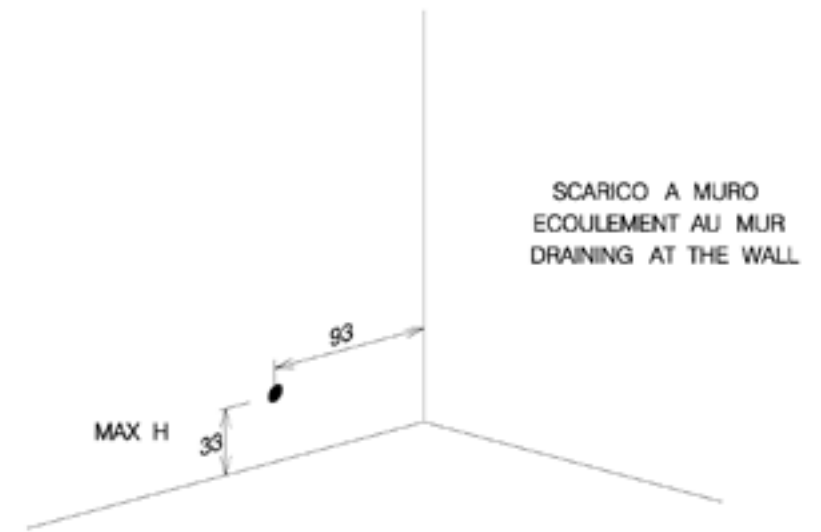
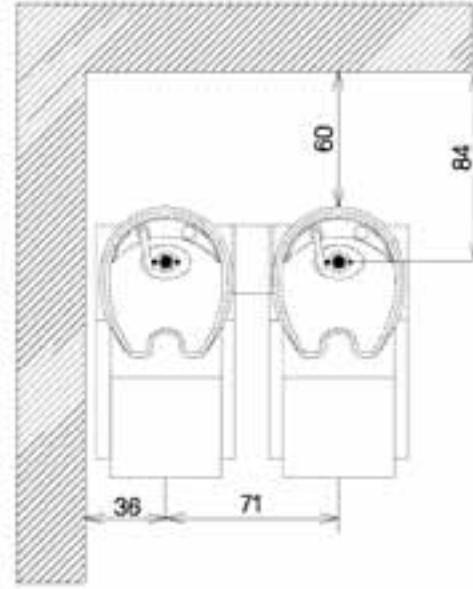
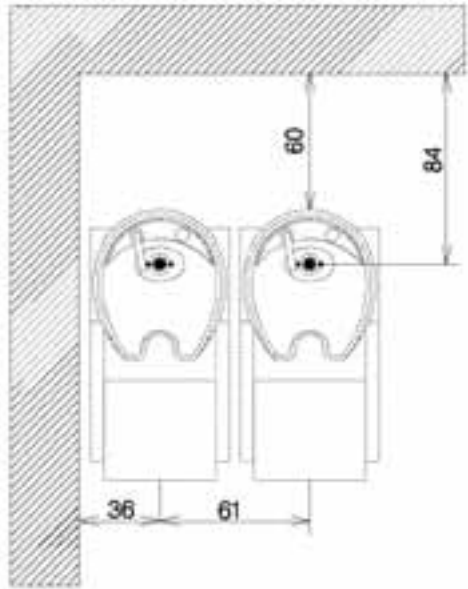



**VEZZOSI SRL**  
VIA MARTIRI DELLA ROMANIA, 9  
42020 BORZANO - ALBINEA (RE) ITALY  
TEL+39 0522 591721  
FAX +39 0522 591298  
[www.vezzosiarredamenti.com](http://www.vezzosiarredamenti.com)  
[info@vezzosiarredamenti.com](mailto:info@vezzosiarredamenti.com)